

Neutron Imaging Study of the Water Transport Mechanism in a Working Fuel Cell

Muhammad Arif
David L. Jacobson
Daniel S. Hussey

Physics Laboratory

NIST

National Institute of
Standards and Technology
Technology Administration
U.S. Department of Commerce

May 25, 2005

This presentation does not contain any proprietary or confidential information

Overview

Timeline

Project Start : 2001

Project End : Continuing

Funded Until 09/30/05

Percent Complete: 100%
of each year target

Budget

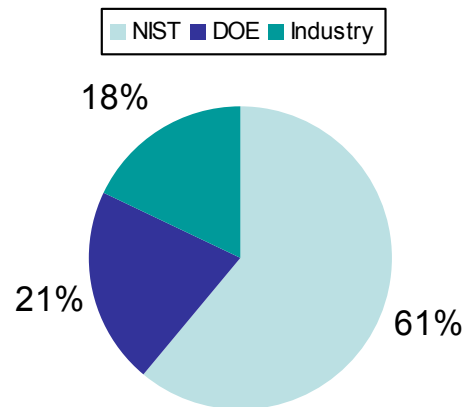

FY04 DOE Funding: \$200K

FY05 DOE Funding: \$300K

Barriers Addressed

Thermal and Water Management.

Water management techniques to address humidification requirements and maintain water balance.

Major Collaborators (2005)

University of Kansas

University of Michigan

Rensselaer Polytechnic Institute

Sandia National Laboratory

General Motors

Daimler Chrysler

Plug Power

Over 30 users trained from universities, national laboratories and corporations

Objectives

This National Institute of standards and Technology project is intended to develop an effective neutron imaging based, non-destructive diagnostics tool to characterize water transport in PEM fuel cells. Objectives include:

1. **Providing** research and testing **infrastructure** to enable the fuel cell / hydrogen storage industry to test commercial grade fuel cell flow field designs;
2. **Training** industry to enable them to use the imaging facility independently;
3. **Transferring data interpretation and analysis algorithms techniques** to industry to enable them to use research information more effectively and independently.

Approach

1. Develop high resolution neutron imaging capability/facility for *in-situ non destructive study of water/hydrogen transport in PEM fuel cells while in operation* and hydrogen transport/distribution in hydrogen storage media
2. Develop capability for accurate data interpretation and quantitative image processing
3. Develop/ provide infrastructure/facility for testing fuel cells
4. Test fuel cells with partnership with industries and academia. Evaluate impacts of research.
5. Transfer technology to industry as it matures
6. Get feed back from users and seek opportunities for future technical breakthroughs

Neutron Imaging of a Fuel Cell

- Image is a radiograph just like an X-ray in the hospital
- Shadow image where the intensity is proportional to the amount of material
- The neutron cross section is very different than the X-ray cross section
- The neutron cross section for hydrogen is very large relative to Al, Cu and C, which are common fuel cell components.
- Neutron imaging is sensitive to 10 μm to 50 μm of liquid water in an operational fuel cell.

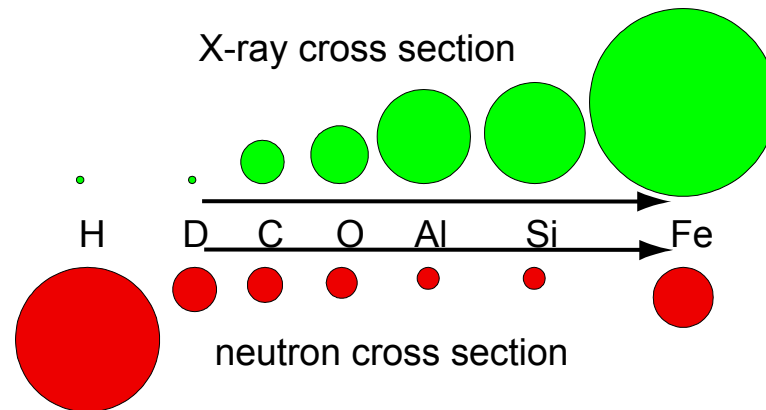
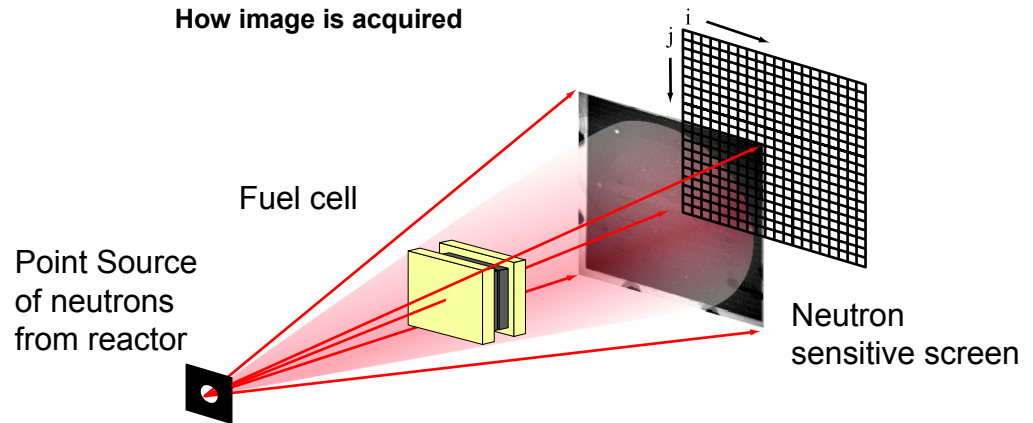

Current BT-6 Neutron Imaging Facility

- Due to be decommissioned summer of 2005
- CCD based imaging
- Real Time imaging added late 2004
- Experimental area has limited space for fuel cells and support equipment.

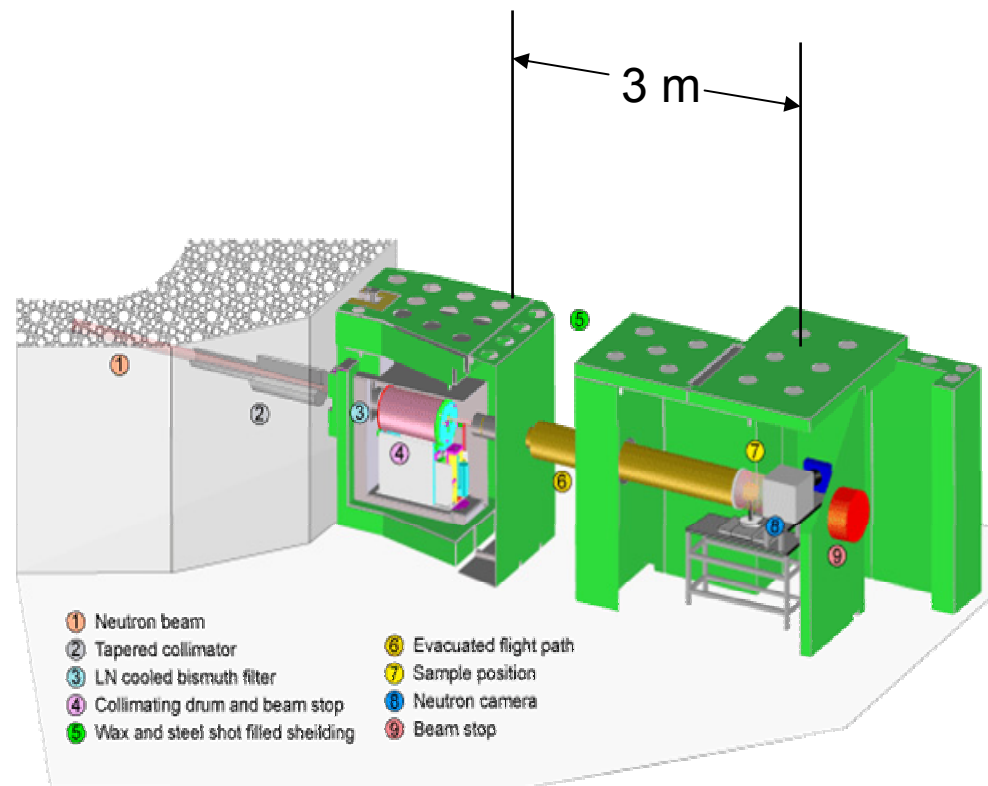

Facility use

Facility Operates nearly 260 days a year (24 hour day)

2004 operating budget nearly \$1.0 m (including equipment cost)

Stringent hydrogen safety procedures

Access requires beam allocation request and approval

Users go through extensive radiation and laboratory safety training

Typical time for a single visit is about a week

Useful data can be obtained within a few hours

Nearly 2 terabytes of data is accumulated for a typical 1 week experimental run

Proprietary data is removed from the facility by users while departing

Both proprietary and non-proprietary research

- Non-proprietary is free of cost recovery fees (currently about 30% of total beam use)
 - Requires information be made available through peer reviewed publications
- Proprietary use requires amortized daily reactor and personnel cost recovery (about 70% of current beam use)
 - Preferred by most industry
 - Results are confidential

Accomplishment: Real Time Imaging

Milestone: Improve time resolution to 30 frames/sec to provide near real time imaging capability for large samples

New Infrastructure

- Large area fast Flat panel detector is operational. Can image fuel cell up to 8 inches X 10 inches in cross-sectional area. Best time resolution is about 0.04 sec (30 frames/sec)
- Software development for the detector is nearly complete
- The new detector is being used by industry/researcher
- Allowing unprecedented capability for 3-D fuel cell imaging

Amorphous silicon detector with 30 fps readout



Front view

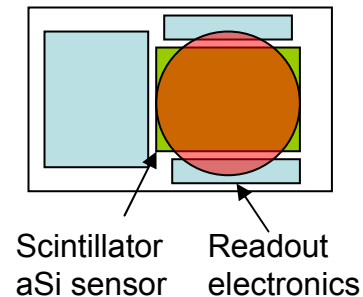

Side view

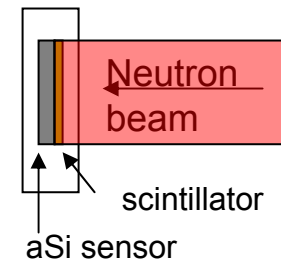

Accomplishment: Polarization Curve

- Measured transient water content during a step from OCV to 1.5 A cm⁻²
- Combined with current density and cell potential can plot out the polarization curve and visualize the mass transport simultaneously.

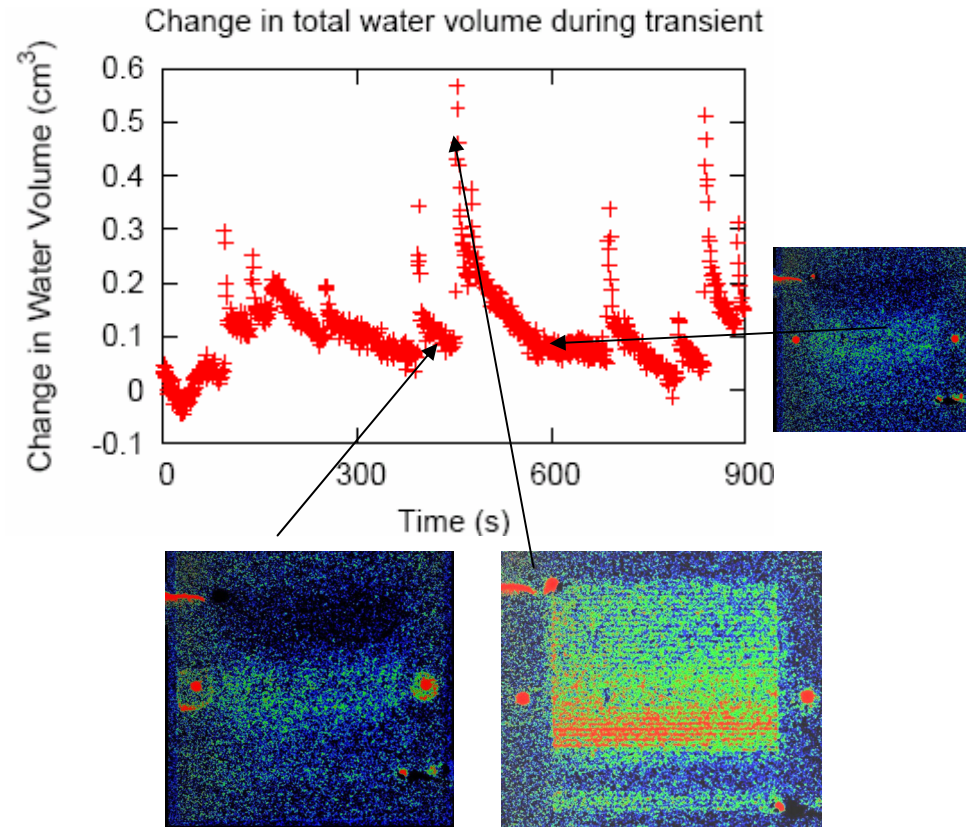
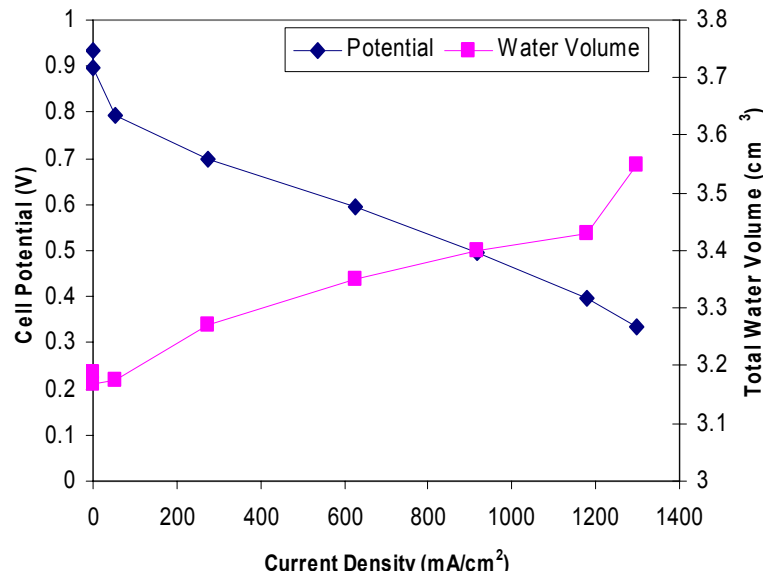

In collaboration with M.A. Hickner and M.P. Siegel from Sandia National Laboratory

Accomplishment: 3-D study of fuel cells

Following 3-D neutron dynamic images shows the capability of near real time imaging/study of the different layers in a fuel cell

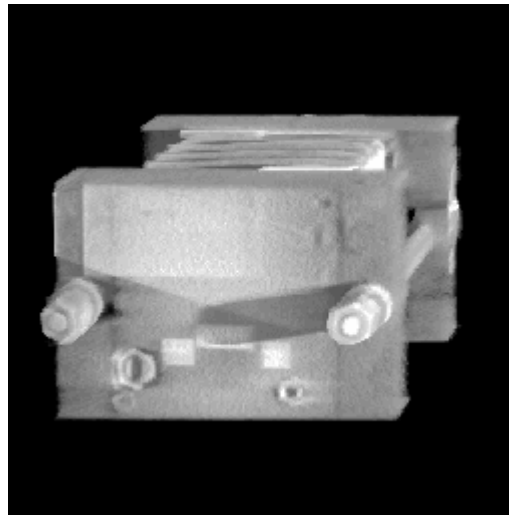

Accomplishment: Fuel Cell GDL Diagnostics

- Innerdigitated design allows study of GDL materials.
- Direct measurement of water uptake in GDL

See for example:
W. He, G. Lin, T.V. Nguyen,
AIChE J., Vol. 49, No. 12
(2003).

Calibrated 40 kPa (uncertainty 0.25 kPa) differential pressure sensors in the cathode inlet and outlet

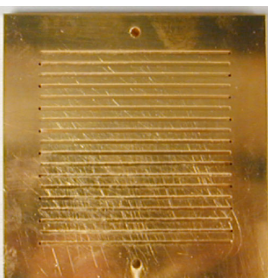
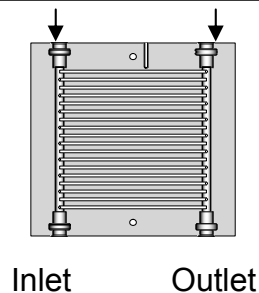
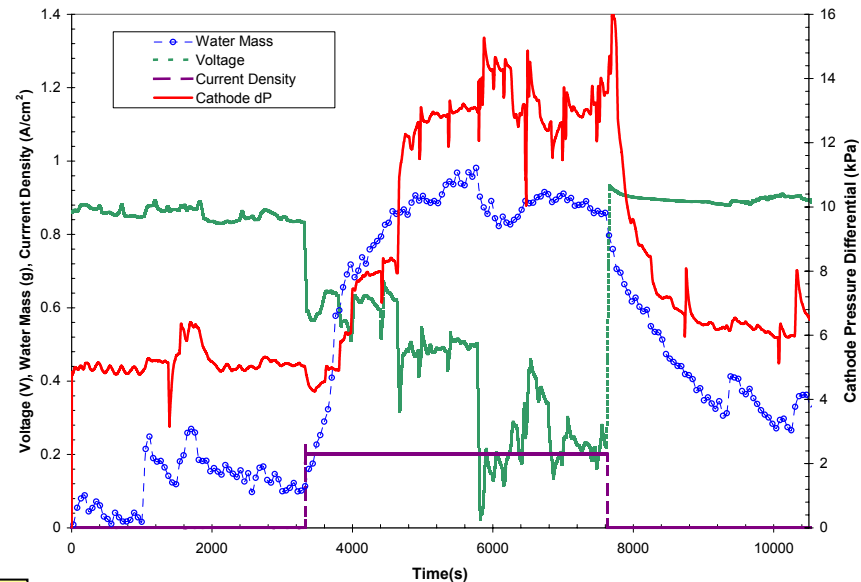

Photo of cathode interdigitated design. Electrode is aluminum protected by gold.



J. Owejan, T. Trabold, D. Jacobson, D. Baker, D. Hussey and M. Arif
Journal of Heat and Mass Transfer (submitted)

Porosity of GDL Materials

- Porosity of GDL is important for modeling
- Current porosity data is very limited and is not directly related to GDL materials used in fuel cells
- Currently studies are underway using neutron tomography and imaging to measure water uptake in GDL materials directly.

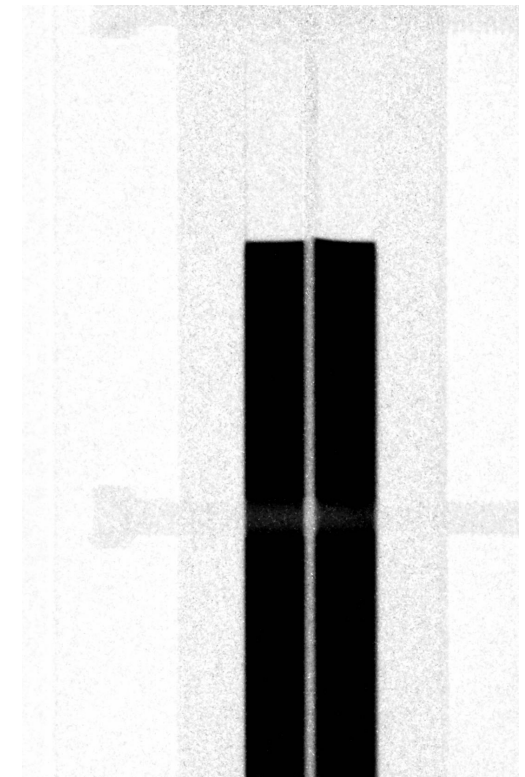

Neutron transmission through GDL. No obvious water uptake.

Reviewers' Comments

- DOE should team with NIST for Non-Proprietary publishable results for the benefit of the whole fuel industry
 - Will be publishing four papers this year describing non-proprietary research results with industry and academic institutions. A total of about 8 presentations have been made (or will be made) at various forums.
- This technology should be aligned with modelers to refine their models
 - We have made contacts with various academic institutions which may use this diagnostic tool for modeling purposes.
- Show some feasibility study to lower resolution to 10 micrometer and the path/cost to get there
 - We are addressing this technologically challenging issue and during the next few slides outline and progress will be shown.

Future plans

- Remainder of FY 2005
 - Install new facility
 - Hydrogen supply
 - Fuel cell test stand
 - Implement fast 3 dimensional techniques to study fuel cells
 - Acquire new high resolution detectors with 25 micron spatial resolution
 - Study the neutron implementation of coded source methods
- FY 2006:
 - Incorporate coded source methods into a neutron imaging system
 - Provide testing capabilities of GDL materials and direct neutron imaging porosity testing.
 - Test further ideal flow field geometries with real time methods.

Future Work: Coded Source Imaging For MEA

- Coded Imaging is widely used in observational astronomy and medical imaging (emission images). As a technique, Neutron Imaging suffers from a lack of intensity.
- Coded Images from a pinhole array with a particular structure can be reconstructed without artifacts.
- We have demonstrated coded imaging in the transmission case using simulations and visible light.
- We will demonstrate Neutron Coded Source Imaging with a proto-type mask in early May.

Detected Image using different number of pinholes

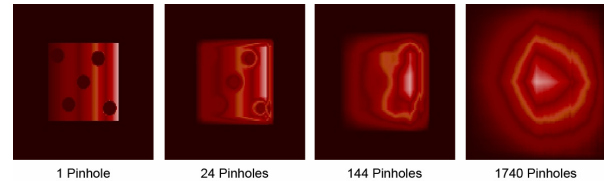

Simulated Coded Image Formation and Reconstruction

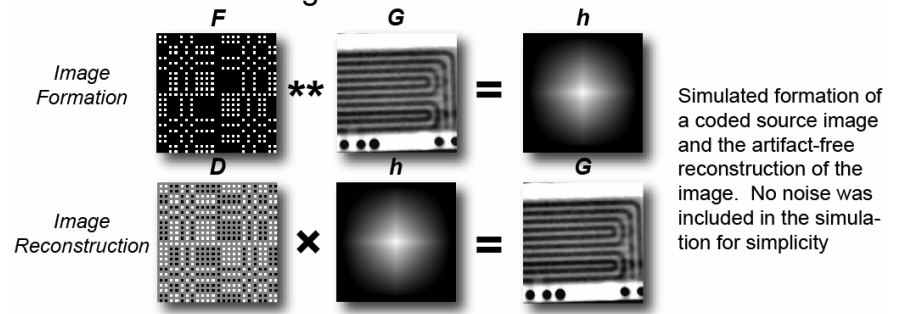

Reconstruction of “real data” using visible light

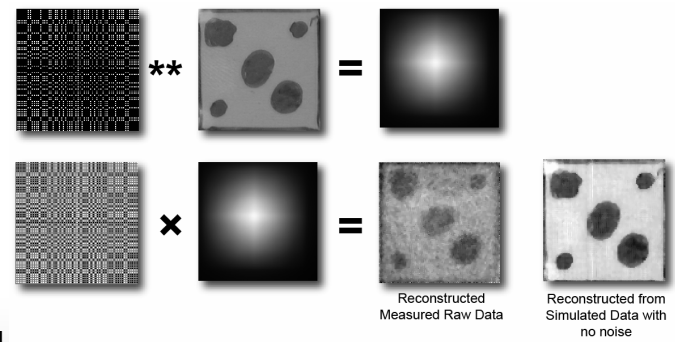

Future Work: Coded Source Laminography

- Reconstructed image depends on the source-sample distance
 - Can obtain 3-D information (Laminography) from **one 2-D image**.
 - If the reconstruction algorithms can achieve the desired depth resolution, coded source laminography would enable real-time (>1 Hz) 3D imaging of an operating fuel cell.
- Imaging could be used for direct study of the MEA
 - Coded source imaging may revolutionize study of laminar samples

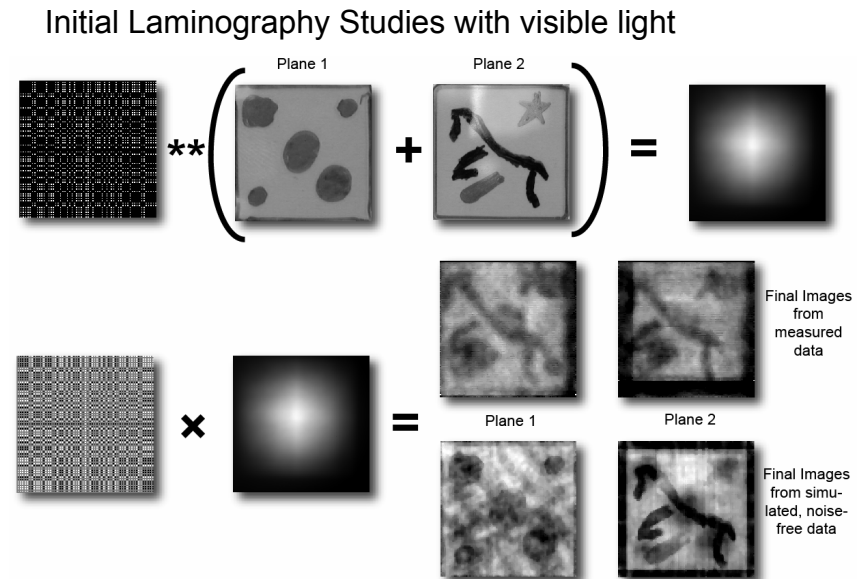

New: BT-2 Neutron Imaging Facility

New Infrastructure

- **Much larger facility** than previous for fuel cell equipment next to beam line.
- **Higher flux** therefore better real time capture capability.
- Flux as high as $10^8 \text{ n s}^{-1} \text{ cm}^{-2}$ available at L/d of 200.
- Beam size of **25 cm diameter** available.
- **Hydrogen** gas supply will be **18.8 slpm** (can be expanded).
- Cylinder **nitrogen** all flow rates
- House **air** (dry, filtered) all flow rates
- **Fuel cell test stand** available and supported for 50 cm^2 hardware.

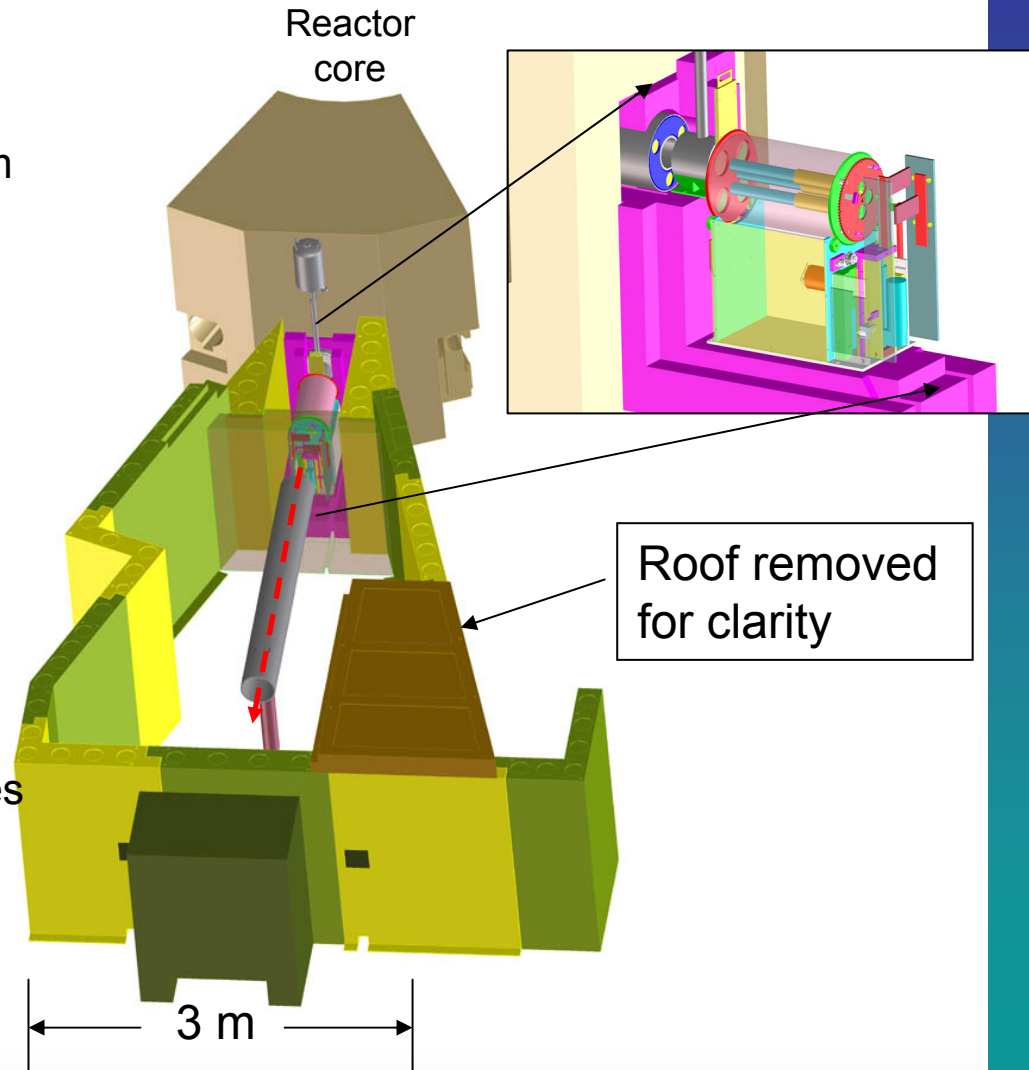

In Conclusion

- We have expanded our user base to encourage open research
- We have already met our milestone and nearly finished with our specific tasks for FY05
- We are developing cutting edge technology to meet future need
- We are developing new facility to meet the need of rapidly growing user base
- We are providing and will continue to provide uniquely powerful, one of a kind diagnostic tool that is helping US industry to solve real world problems in fuel cell research

Publications

- R. Satija, D.L. Jacobson, M. Arif, S.A. Werner, “In situ neutron imaging technique for evaluation of water management systems in operating PEM fuel cells”, *Journal of Power Sources* 129 (2004) pp. 238–245.
- D.Hussey, D.L. Jacobson, M. Arif, P.R. Huffman, R.E. Williams, J.C. Cook, "New Neutron Imaging Facility at the NIST", *Nuclear Instruments and Methods A*, (available online)
- T. Trabold, J. Owejan, D. Jacobson, M. Arif and P. Huffman, “In-Situ Investigation of Water Transport in an Operating PEM Fuel Cell Using Neutron Radiography: Part 1 - Experimental Method and Serpentine Flow Field Results”, (submitted *International Journal of Heat and Mass Transfer*).
- J. Owejan, T. Trabold, D. Jacobson, D. Baker, D. S. Hussey, M. Arif, “In-Situ Investigation of Water Transport in an Operating PEM Fuel Cell Using Neutron Radiography: Part 2 - Transient Water Accumulation in an Interdigitated Cathode Flow Field”, (submitted *International Journal of Heat and Mass Transfer*).

Presentations

- The 2004 Fuel Cell Seminar – Bin Du (Plug Power)
 - Title: Neutron Radiography As A Tool For In Situ PEM Fuel Cell Diagnostics
- The 2004 Gordon Conference: Fuel Cells– David Jacobson (NIST)
 - Title: Understanding mass transport in fuel cells using neutron imaging

Upcoming

- Joint Meeting of the 2nd International Conference on Green and Sustainable Chemistry and the 9th Annual Green Chemistry and Engineering Conference – Bin Du (Plug Power)
 - Title: Tuning hydrogen content for improved PEMFC water management: A neutron radiography study.
- The 2005 Fuel Cell Seminar – David Jacobson (NIST)
 - Title: Neutron Imaging at NIST: An in situ method for visualizing and quantifying water dynamics in low temperature PEM fuel cells.

Hydrogen Safety

The most significant hydrogen hazard associated with this project is:

Hydrogen gas accumulating in the experimental hall without being detected, creating potential fire and explosion hazard.

Hydrogen Safety

Our approach to deal with this hazard is:

- All hydrogen related safety procedures are reviewed by the hazard review committee
- Hydrogen is produced using an on-demand hydrogen generator that stores very small amount hydrogen in the system minimizing the potential release of unsafe amount of hydrogen gas.
- In addition the NIST research facility currently uses hydrogen sensors to detect build up of hydrogen gas. These detectors are calibrated regularly with 1% hydrogen in air gas mixture.
- Additional sensors are used near the experiment itself to monitor possible hydrogen leak.
- The fuel cell generators are equipped with rapid one button shut down capability in the event of an emergency.