

50 kW Absorption Enhanced Natural Gas Reformer

Jim Stevens

ChevronTexaco Technology Ventures

May 25, 2005

Timeline

- Start: 10/1/03
- End: 9/31/06
- Percent Complete: 33%

Barriers

– Hydrogen Production

- A. Fuel Processor CAPEX
- B. Operation and Maintenance

– Crosscutting Barriers

- Catalysts
- Hydrogen Separation

– Fuel Flexible Processors

- J. Durability
- K. Emissions
- L. Hydrogen Purification
- M. Efficiency
- N. Cost

Budget

- Total Project: \$9.0 MM
 - DOE share: \$5.6 MM
 - CTTV share: \$3.4 MM
- FY04 funding: \$1.4 MM
- FY05 funding: \$1.9 MM

Partners



Objectives

- Overall Objective

- Develop materials, process, and 50 kW natural gas absorption enhanced reformer capable of providing near pure H₂ that meet DOE targets for efficiency and H₂ cost

- 2004 Objectives

- Develop and test high durability CO₂ sorbents
- Build and operate two 1kW reformers
- Model process and demonstrate potential for high efficiency and reduced capital costs

Approach- Absorption Enhanced Reforming

- A. Combine reforming, water gas shift, and CO₂ sorbent in one reactor to produce near pure H₂ with low CO₂ and CO content.
- B. Use methanation to reduce CO and CO₂ to <1ppm.
- C. Develop CO₂ sorbent with 40,000 hour life while maintaining acceptable CO₂ fixing capacity.

Chemistry of AER



Reforming Step



Regeneration Step

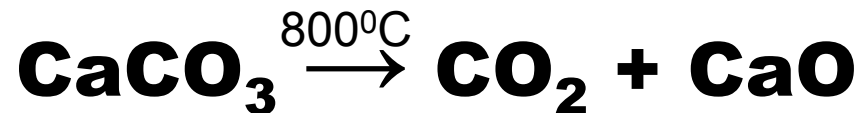

Example Reformate Composition

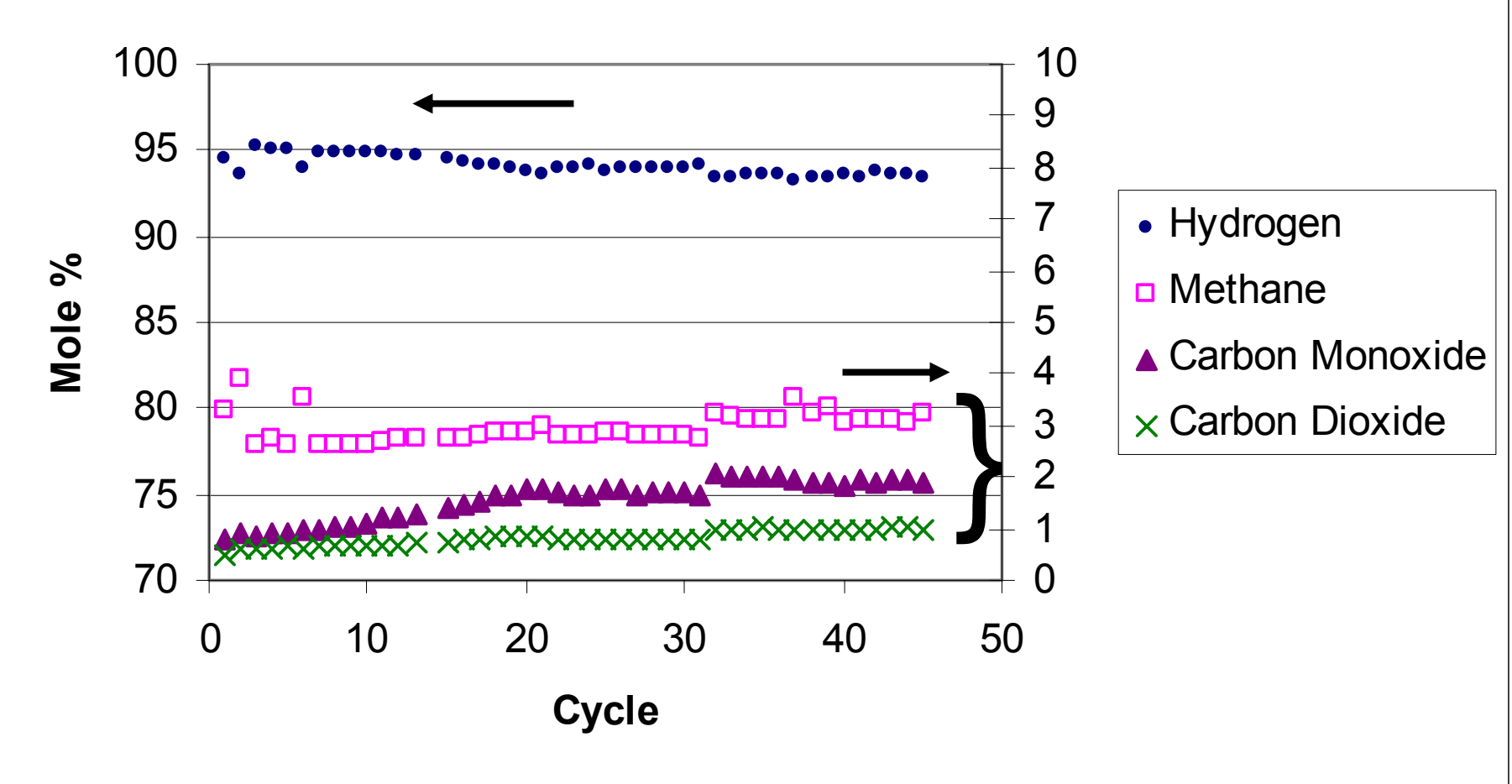

AER Materials Requirements

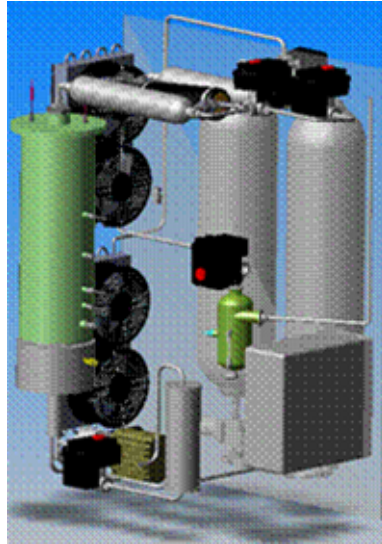

- **Reforming/WGS catalysts active at 600°C**
- **Reversible Sorbent**
 - High CO₂ sorption capacity (>20 wt%)
 - Fast kinetics
 - Long term stability
 - Crush strength (>2.0 lb/mm)
- **Scalable sorbent production**

Long Term Stability of CSMP Sorbent Powders CT CO₂-TGA Results from Typical Samples

Carbonation 600C, Decarbonation 800C (for 1~9th cycle of C2872-41-32 decarbonation at 750C

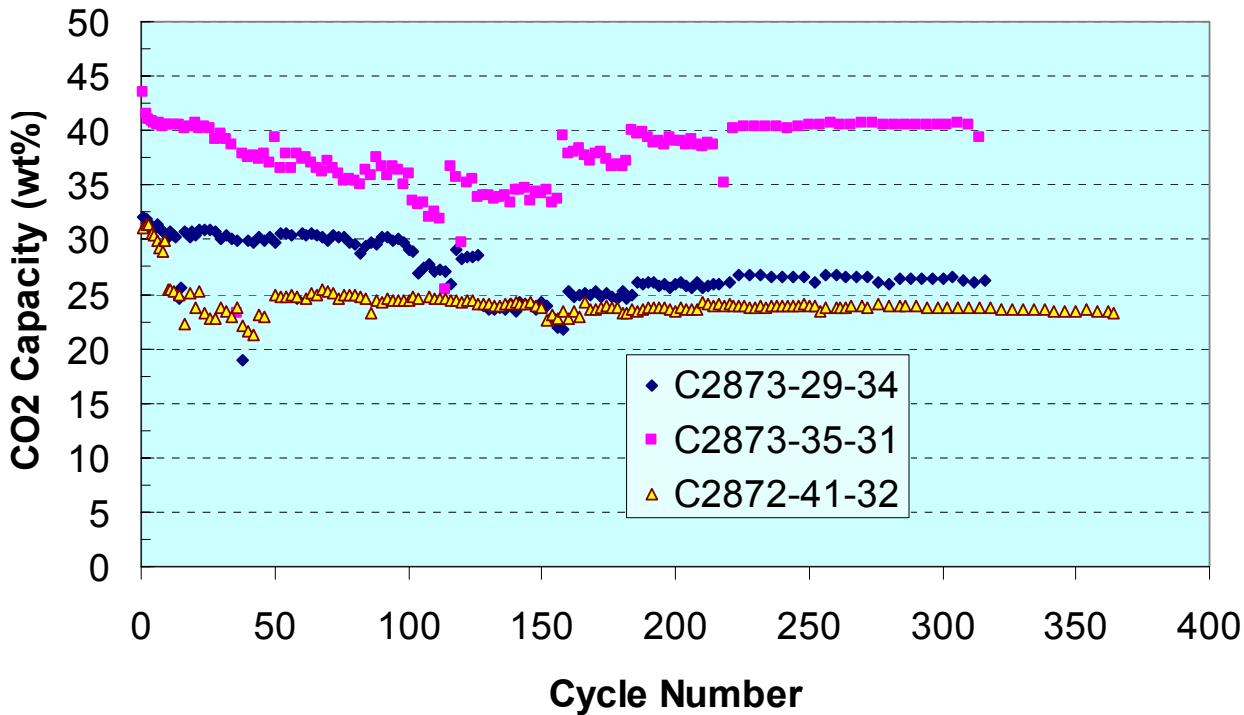

Summary

- C2872-41-32 has been running since 01/27/2003
- >3000 h lifetime

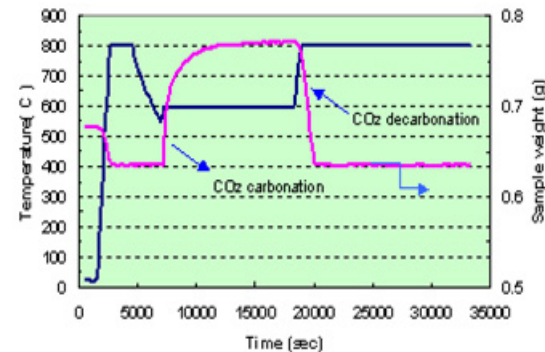

Comparison of CO₂-TGA Testing with Reactor Tests

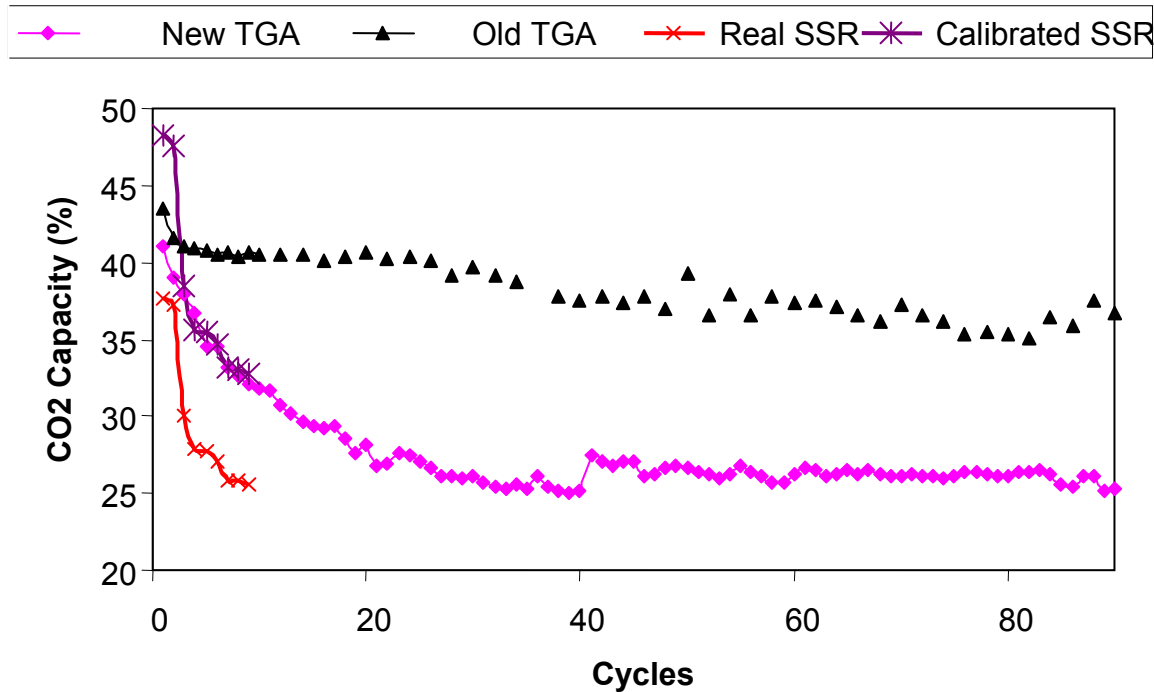

- More than 225 samples tested since June 2004

- 111 extrudates
- 114 powders
- 30 cycles initial screening
- Selected samples – over 500 cycles, 3000 h

– The data from continuous CO₂-TGA cycling test method correlate with the reactor testing results

Effect of Precursor Type on CSMP Sorbent

CO₂-TGA performance

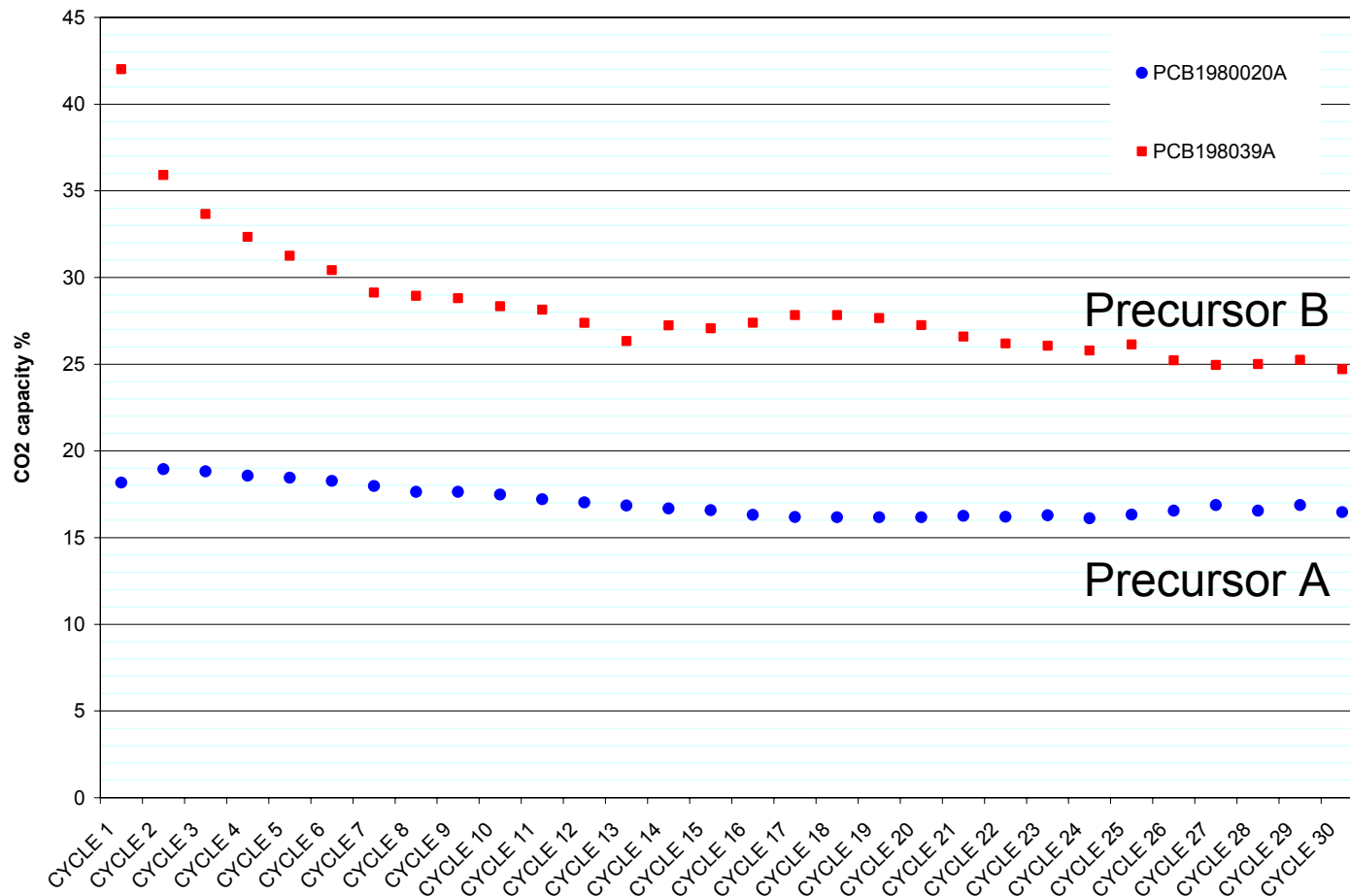

Effect of Inert Additive Content on CSMP Sorbent Performance

•Summary:
Inert additive loadings of 5-15 % show similar results after 30 cycles

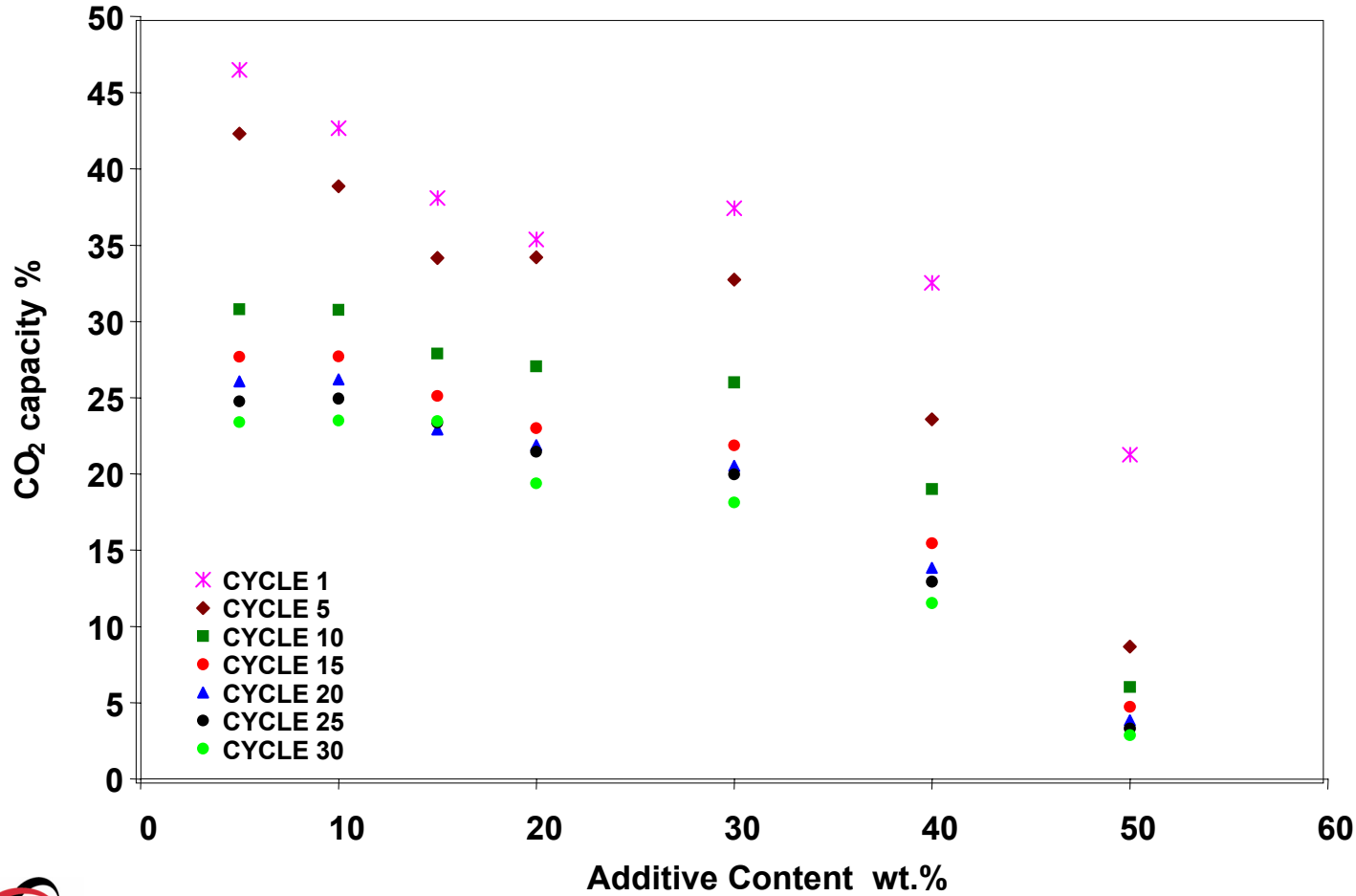

Stability of Extrudates

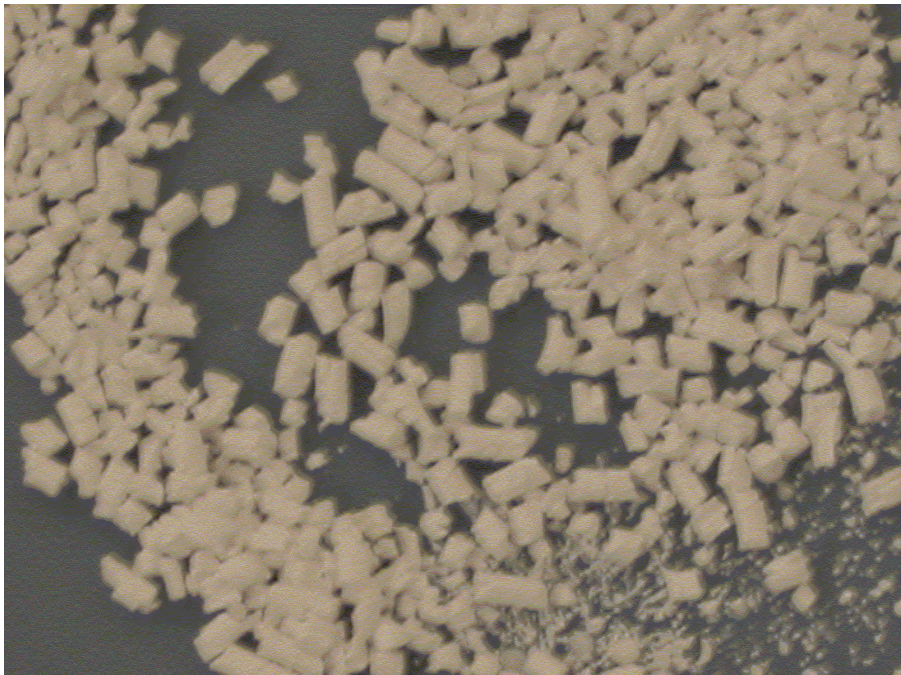

Extrudate A, after 535 cycles

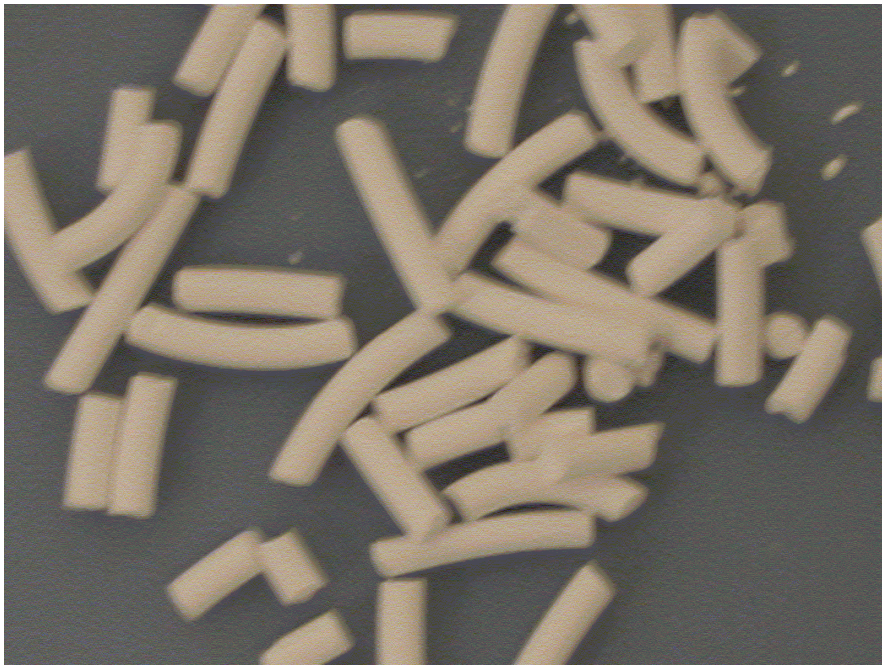

Extrudate B, after 523 cycles

Integrated Materials for AER

Demonstrated

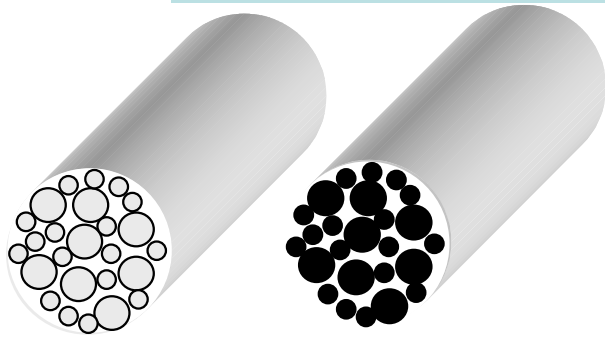

CaO Rh/Al₂O₃

1.

Demonstrated

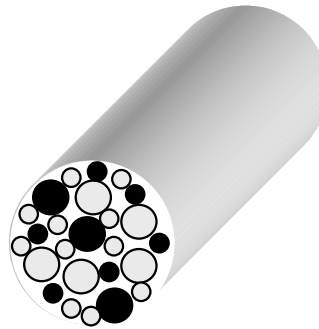

Mixture

2.

In Progress

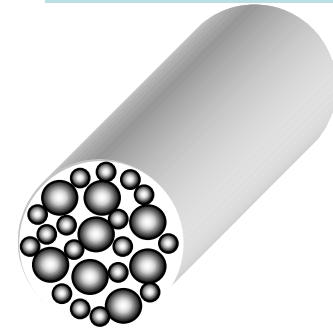

Composite

3.

1. Sorbent (S) and reforming catalyst (RC) made in a separate pellets
2. Sorbent and reforming catalyst made as separate powders
3. Sorbent and reforming catalyst made in one particle

Regeneration Method

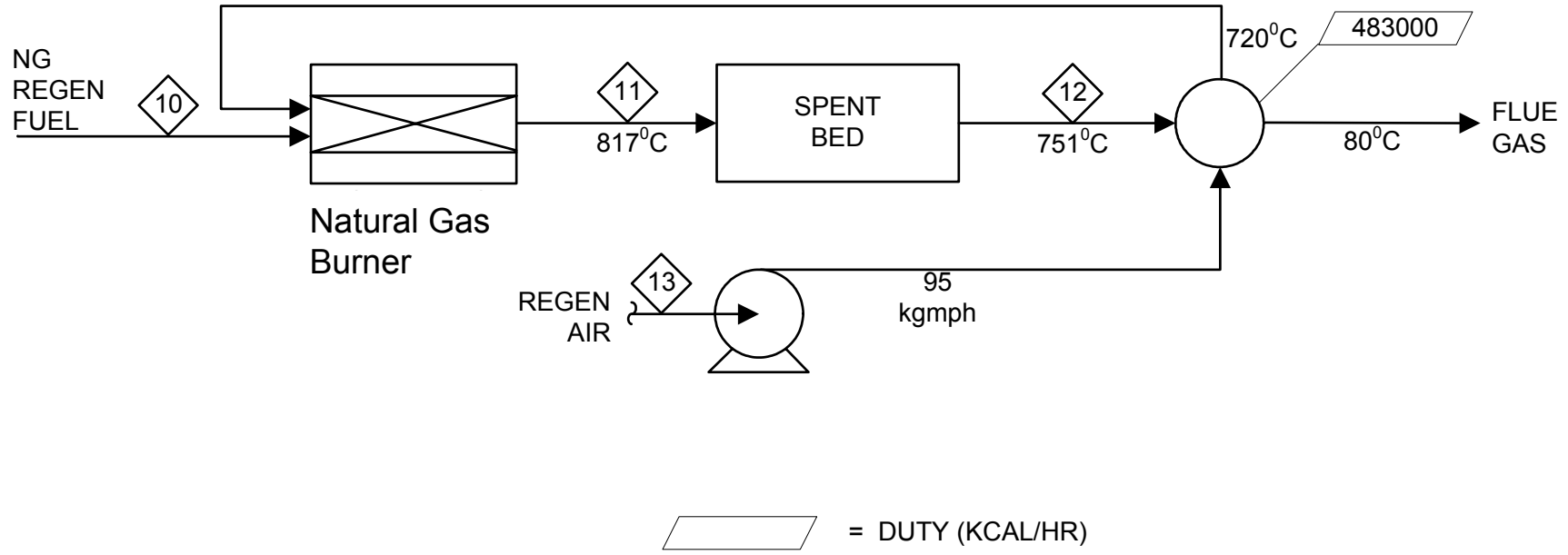

SENSIBLE HEAT REGEN- AIR

1 kW Reactor Design

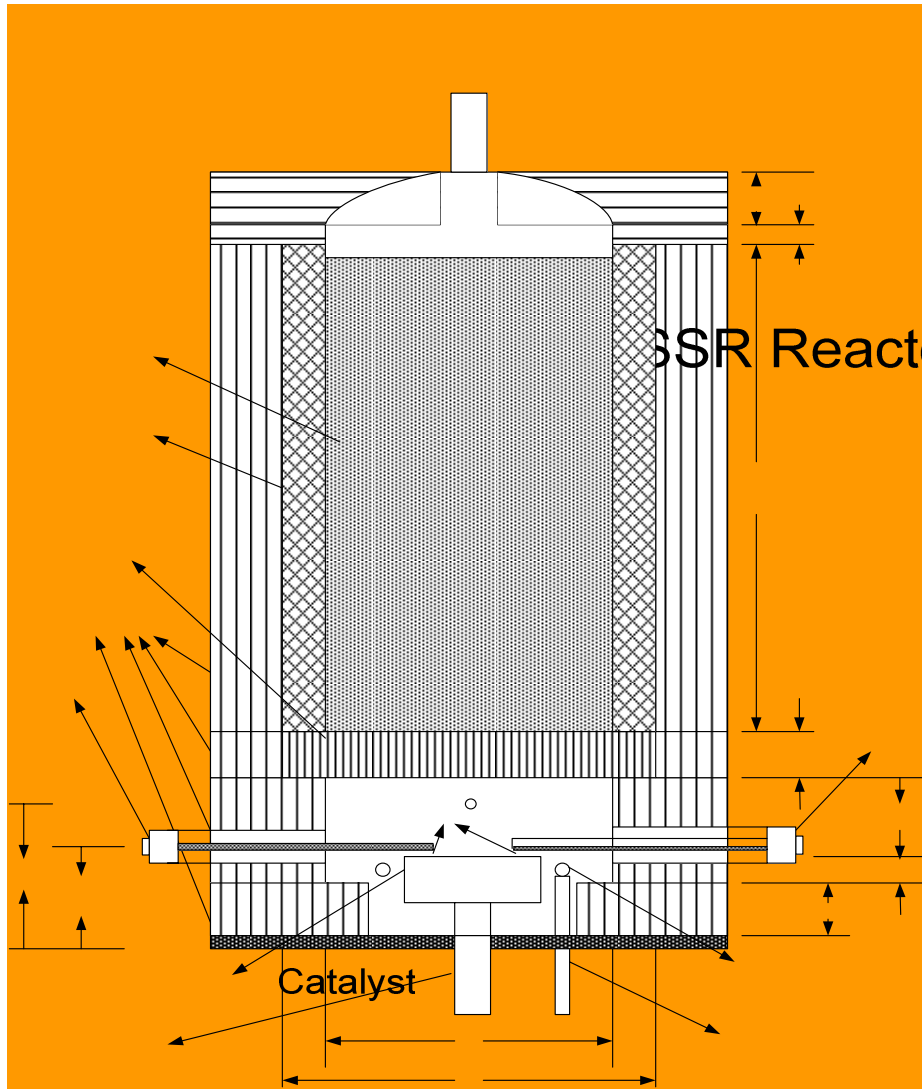

- Simple reactor construction
- Metal fiber burner for combustion during regeneration
- Direct combustion gas/sorbent heat transfer
- Good control of bed temperature.

Zirconia tube

Copyright 2005 ChevronTexaco

Constructed and Testing Two 1 kW Reactors

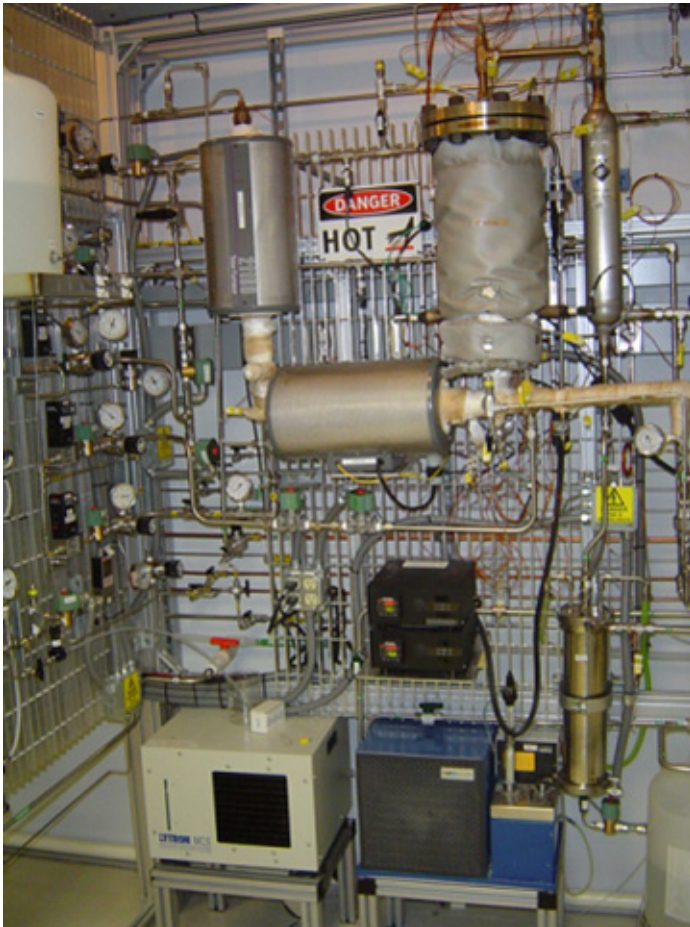

Reviewer Comment: “Durability is a key technical challenge, testing needs to be done under real conditions.”

Sorbent Capacity After Multiple Combustion Gas Regenerations

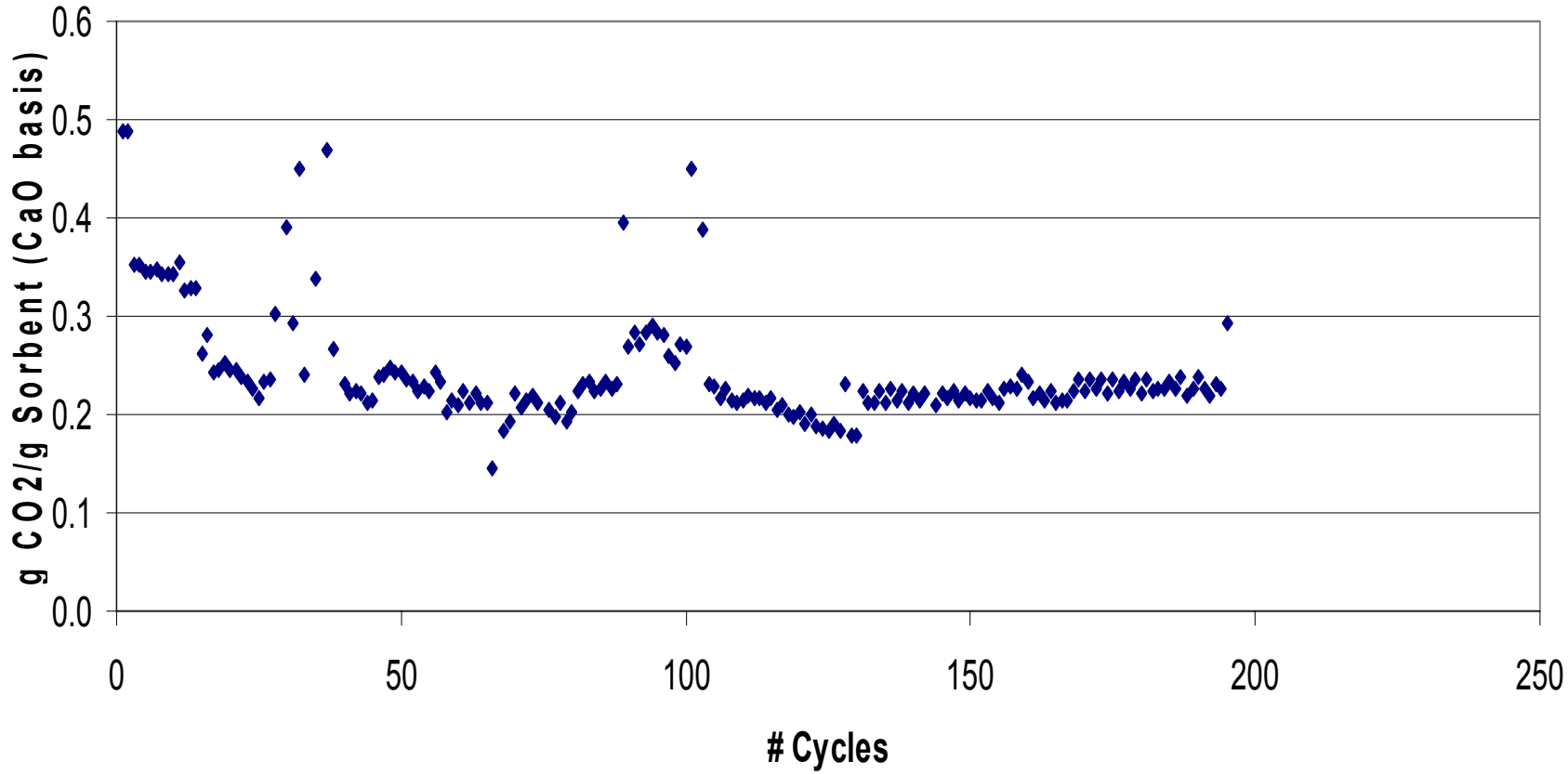

Reviewer Comment: "Durability is a key technical challenge, testing needs to be done under real conditions."

Attrition After 200 Cycles of Reforming/Combustion Gas Regeneration

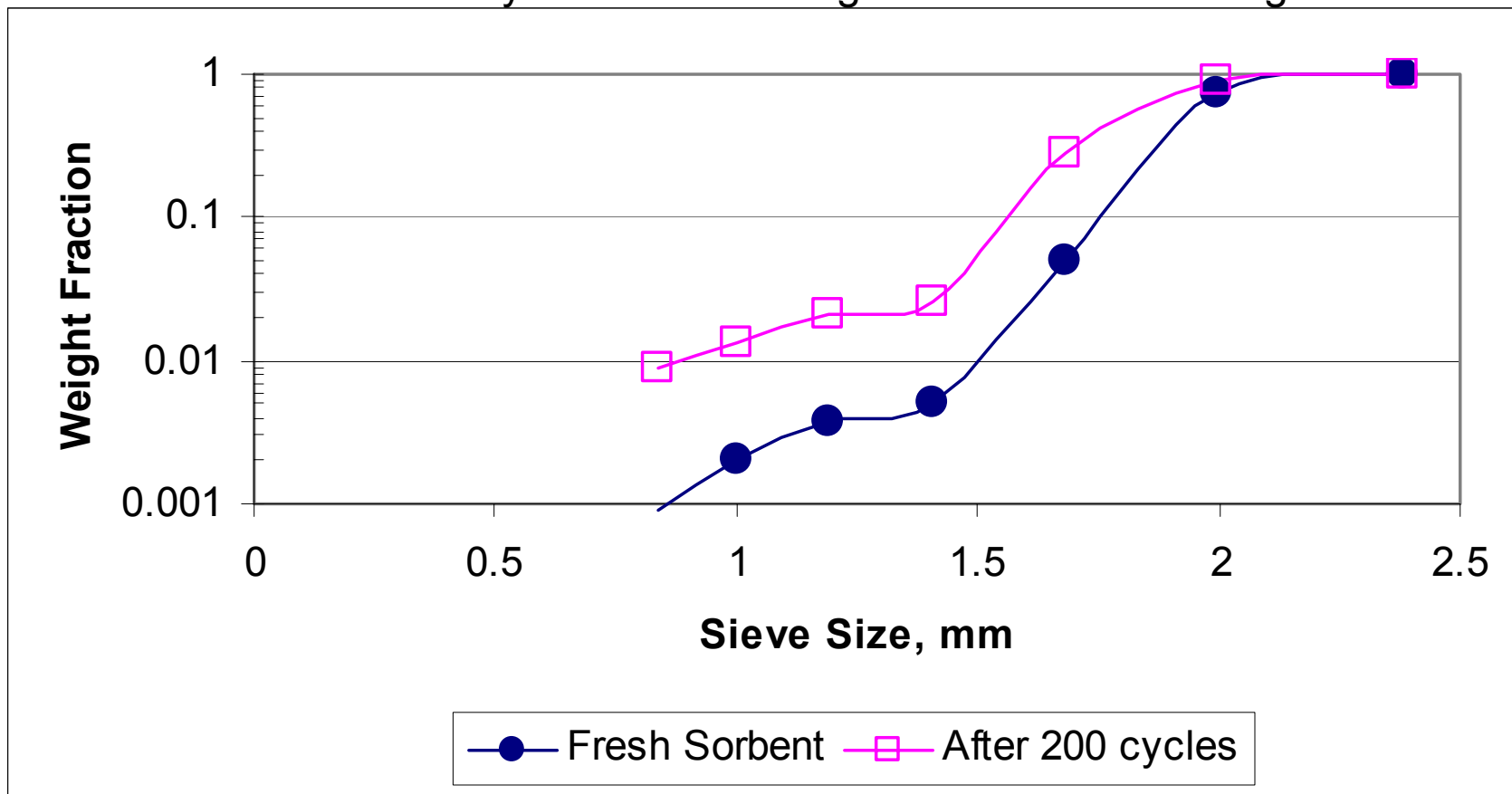

Reviewer Comment: “No clear plan to expand to large plants or sequestor CO₂.”

- CTTV Working on Large Scale Production for Refineries outside of DOE Grant
 - Completed Rough Cost Study on Large Fixed Bed Process
 - Started Study on Entrained Sorbent Reactor
- Sequestration of CO₂ outside scope of DOE Grant
 - More likely feasible for large scale plants
- **Cabot Actively Marketing Materials**

Reviewer Comment: “No need to develop new reforming catalysts, should use commercial reforming catalysts.”

- **Using Engelhard reforming catalyst.**
Some development may be required

Major Milestones for DOE Project

Task	Milestone/Decision point	Deliverable	Date
Steam Reforming Catalyst	90% of the thermodynamic equilibrium conversion of methane ,Rh content <0.5 %Rh	Test data report	09/30/04
Integrated catalyst /sorbent	>50 % CO ₂ fixing capacity after 50 cycles >90 % equilibrium conversion of CO	Test report	09/30/04
Integrated catalyst /sorbent	>98 % H ₂ , CO/CO ₂ < 1% on dry after 50 cycles	Pelletized materials	11/15/04
Integrated catalyst/sorbent	>98 % H ₂ , CO/CO ₂ < 1% after 500 cycles	Pelletized materials	08/15/05
Reactor concept modeling	Predicted efficiency of system > 78% and capital cost less than currently available systems	Written report	07/06/04
Catalyst production scale up	Deliver enough integrated material for one full scale reactor, estimated 175 kg	Pelletized materials	11/15/04
Integrated Catalyst delivery	Deliver enough integrated material for one full scale fuel processor, estimated 350 kg	Pelletized materials	08/15/05
10 kw Reactor Installation	Reactor ready for testing	Reactor installation	11/12/04
Reactor Testing	Reactor meets design criteria	Test Report	08/03/05
Reformer Installation	Stand alone reformer installed in Houston Test area	Reformer Installed	09/15/05
Reformer Testing	Reformer start-up/shut-down cycle testing, transient testing, durability testing.	Test Report	11/08/06

Go/No Go Decision Points

<i>Go/No-Go decision points</i>	Decision review package	Criteria	Date
1	Combined reactor concept and materials performance demonstrated	>98 % H ₂ , CO/CO ₂ < 1% on dry basis after 50 cycles predicted energy efficiency > 78%	11/15/04
2	1 kw Reactor performance evaluation	>98 % H ₂ , CO/CO ₂ < 1% on dry basis after durability testing predicted energy efficiency > 78%	7/30/05
3	Fuel Processor Performance	>98 % H ₂ , CO/CO ₂ < 1% on dry basis after 3 months of durability testing measured energy efficiency > 78%	3/30/06

Future Plans

- 2005
 - Continue testing sorbent formulations
 - Continue operation of 1kW reactors
 - Construct 50kW reformer
- 2006
 - Complete sorbent development
 - Test 50kW reformer

Publications and Presentations

- Development of a Fuel Processor Using Revolutionary Materials for Single Step Absorption Enhanced Natural Gas Reforming, 2004 National Hydrogen Association, Los Angeles California
- Cost Effective Production of Near-Pure Hydrogen, 2004 Fuel Cells and Hydrogen Futures Conference, Perth, Australia

Safety Question #1. What is the most significant hydrogen hazard associated with this project?

- Deflagration in reactor due to mixing of air and hydrogen when switching from reforming cycle to regeneration cycle.
 - During the reforming cycle the CO₂ sorption material is saturated and must be regenerated. After purging the system with steam, flue gas from a natural gas burner passes through the reactor to heat and regenerate the sorbent.

Safety Question #2. What are you doing to deal with this hazard?

- Air to burner is controlled by two sequential valves controlled by two separate control systems/sensors.
- Hydrogen is purged by multiple volumes of steam before regeneration begins.
- System is above ignition temperature so combustion will begin before hydrogen/air mixture can reach explosive range
- Pressure relief valves sized to release pressure
- Reactor vessel designed to withstand pressure wave
- Laboratory access is limited
- System is operated within hazard containment area
- Test area has multiple sensors with automated electrical and natural gas shut-offs