

High Density Hydrogen Storage System Demonstration Using NaAlH_4 Complex Compound Hydrides

**D. Mosher, X. Tang, S. Arsenault, B. Laube,
M. Cao, R. Brown and S. Saitta**

United Technologies Research Center
East Hartford, Connecticut



DOE Hydrogen Program

Annual Peer Review

Arlington, VA

May 16, 2007

Project ID STP 33

Overview

■ Timeline

- 4/1/02 Start
- 3/31/07 End
- 99% Complete

■ Budget

- \$3.8M Total Program
 - \$2.7M DOE
 - \$1.1M (28%) UTC
- \$0.8M DOE FY06
- \$0.12M DOE FY07

■ Barriers / Targets Addressed

- System Gravimetric Capacity: 1.5 kWh/kg
- System Volumetric Capacity: 1.2 kWh/L
- Charging Rate: 5 kg H₂ / 10 min
- Safety

■ Partners

- UTC Fuel Cells
- Hydrogen Components, Inc. (HCI)
- Kidde Fenwal
- Albemarle Corporation
- Spencer Composites
- Lyons Tool & Die

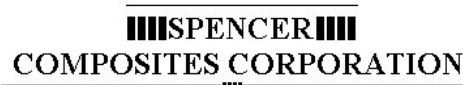

Objectives

Overall Objectives

- Identify and address the **critical technical barriers** in developing complex hydride based **storage systems**, particularly those which *differ from conventional metal hydride systems*, to advance DOE performance targets.
- Design, fabricate and test a sequence of subscale and full scale **NaAlH₄ prototypes** which can be applied to other reversible complex hydrides of similar thermodynamics.

Past Year Objectives

- **Prototype 2 Development & Testing:**
 - Material processing & kinetics modeling
 - Detailed system design and fabrication
 - Powder densification application
 - System testing and model comparison
 - Projections for realistic NaAlH₄ system performance

Overall Approach

Apply modeling, sub-scale experimentation and full scale development to identify & address critical technologies for complex hydride systems:

- Safety Analysis
- Media Kinetic Experiments & Modeling
- Heat Transfer Analysis & Optimization
- 50 g H₂ Subscale Experiments
- Prototype 1
 - Component design & fabrication
 - Evaluation facility development
- Prototype 2
 - Refined heat exchanger optimization
 - Powder densification
- Fuel Cell Integration Analysis

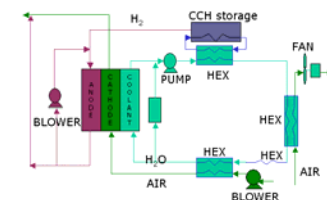
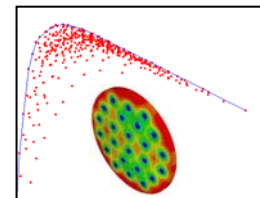
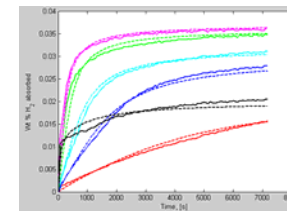

Prototype Development Approach

Goals

Design Elements

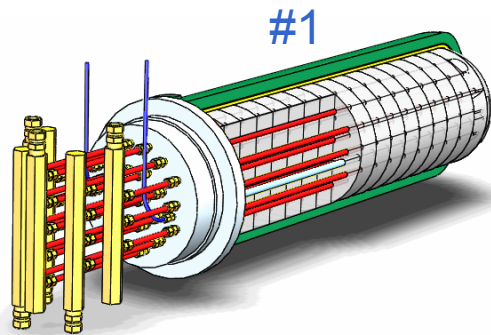
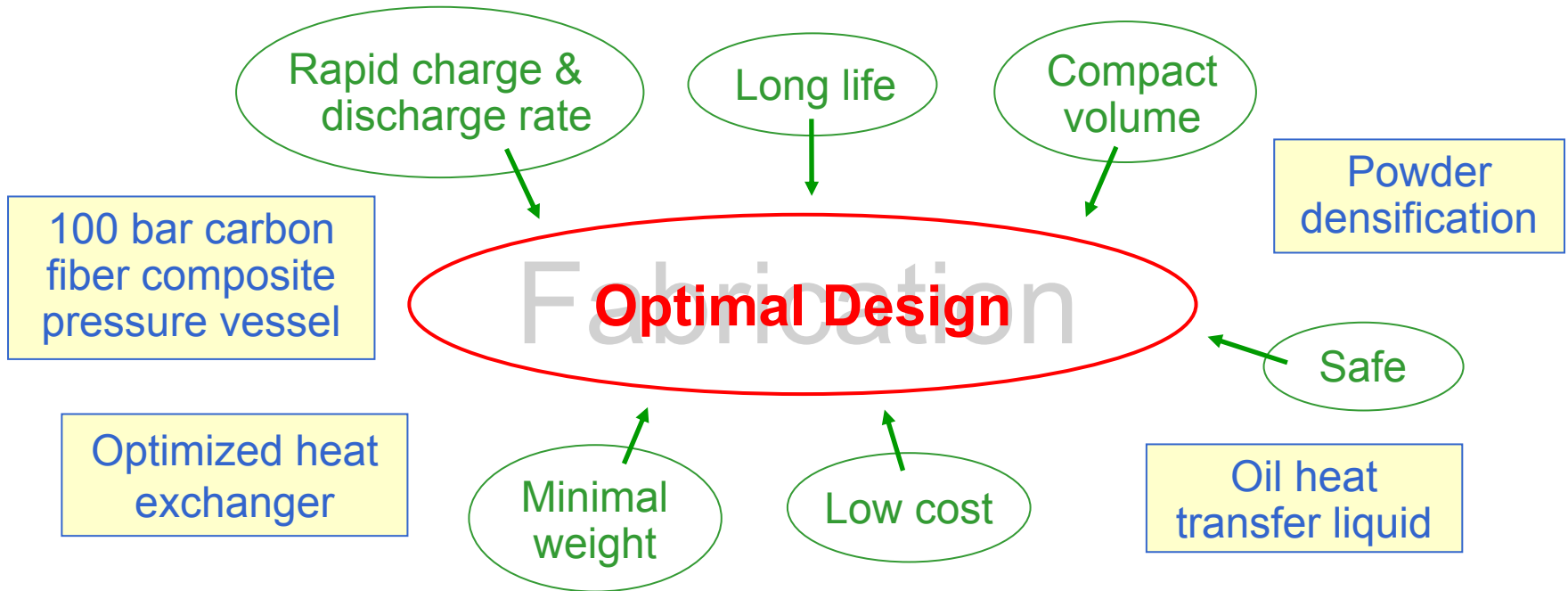

#1
Full scale – 19 kg hydride
Aluminum foam

NaAlH₄
Prototypes

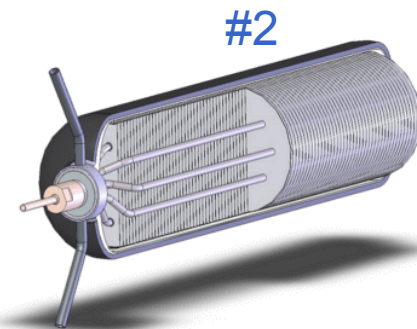

#2
 $(1/2)^3 = 1/8$ scale – 3.5 kg hydride
Aluminum fins

Pressure Vessel & Heat Exchanger Review

Pressure Vessel

Carbon fiber composite exhibits increasing improvement over stainless steel at higher pressures.

Gravimetric efficiency \equiv
(kg hydride / kg system)

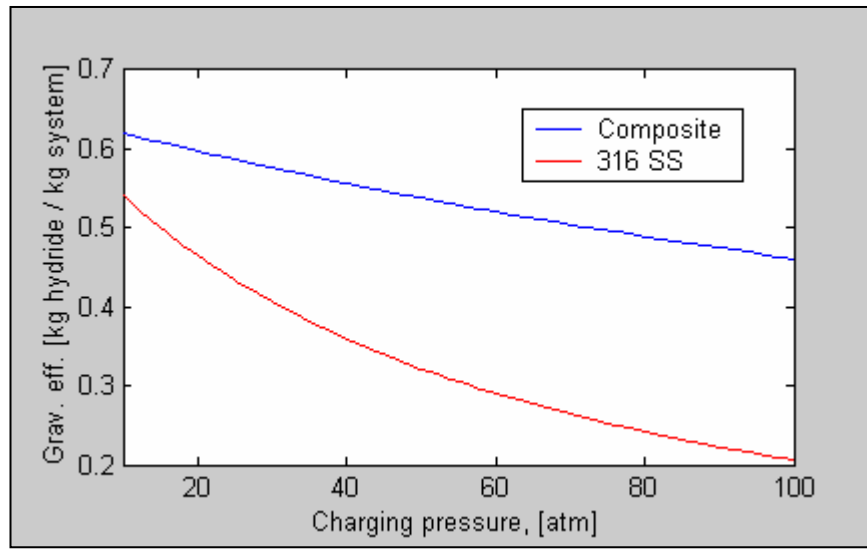

Heat Exchanger

Optimally balanced **design points** for prototype 2 finned tube heat exchanger:

- Fin thickness
- Fin spacing
- Tubing outside diameter
- Tubing spacing

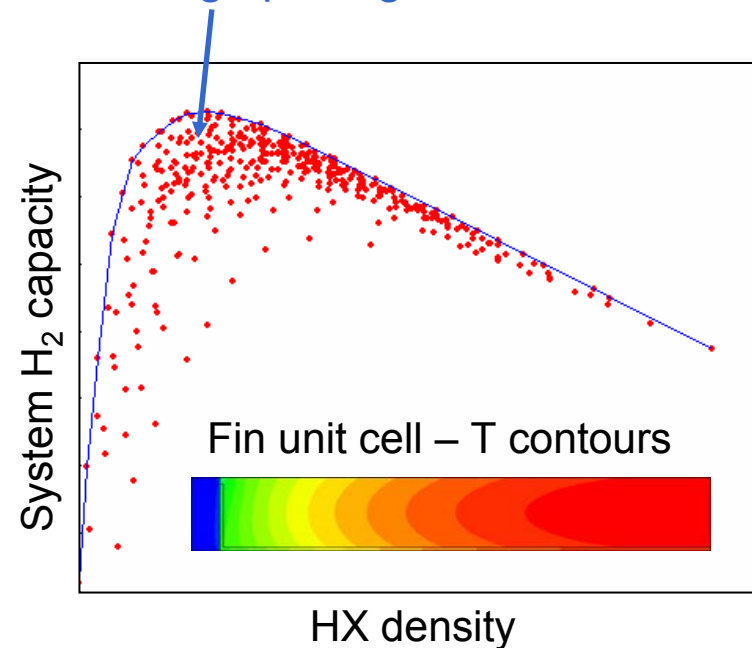

Volumetrics Overview

Energy density is the product of

- *Hydride powder density*
- H_2 weight % capacity
- System volumetric efficiency

Prototype improvement

- Prototype 1: 200 Wh / L
- Prototype 2: 700 Wh / L

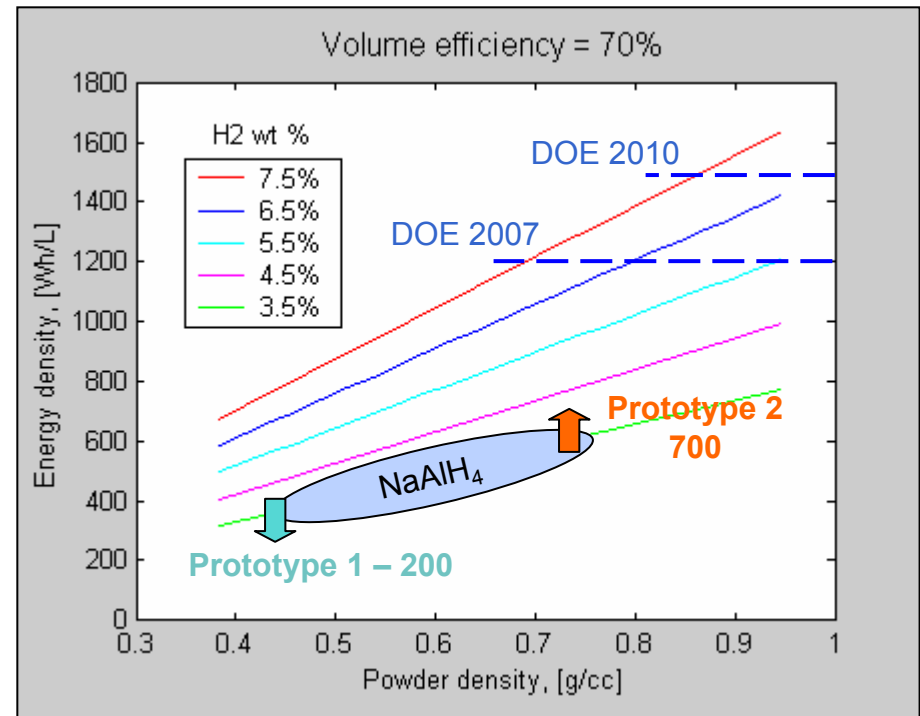

Hydride powder density is as important as H_2 weight % capacity for system volumetric capacity

Powder Loading & Densification Development

Improved volumetrics due primarily to enhanced powder loading methods.

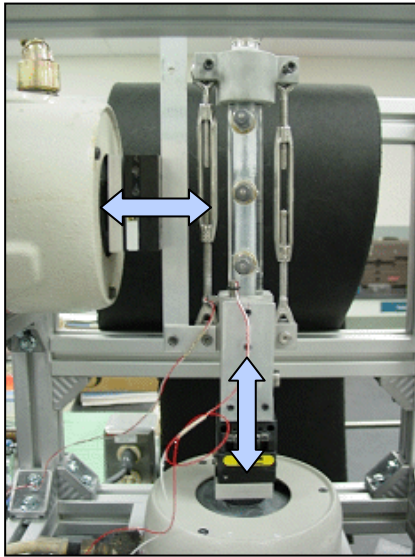

Dual axis vibratory shaker
Controlled amplitudes and
frequencies



Powder column
0.72 +/- 0.02 g/cc

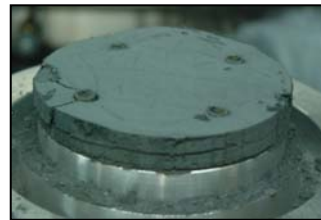

Disassembled finned
test article
> 0.77 g/cc



Prototype 2
0.72 to 0.76 g/cc
Prototype 1
0.44 g/cc

Consistent densities across multiple configurations & geometries

Milling and Densification – NaAlH₄

Ball milling procedures affect not only kinetics, but also have a significant influence on powder densification.



0.64 g/cc

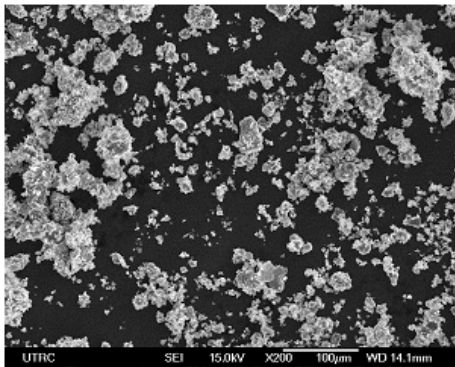

0.85 g/cc

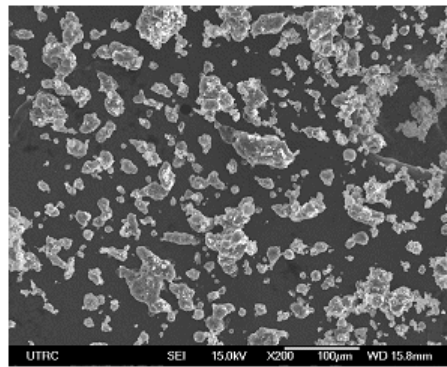

0.72 g/cc

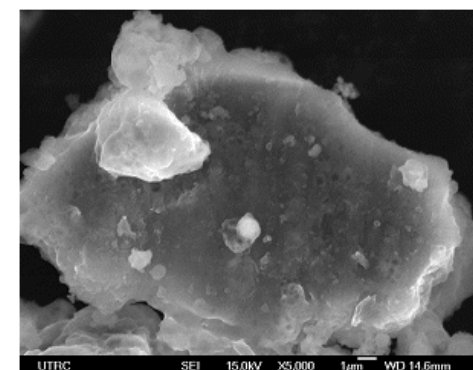
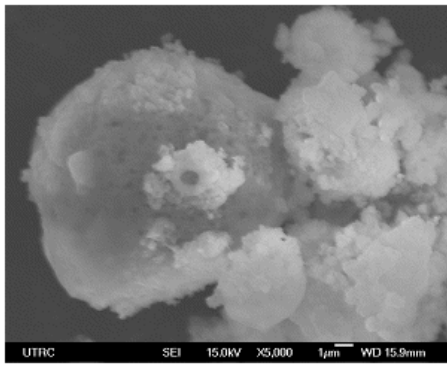
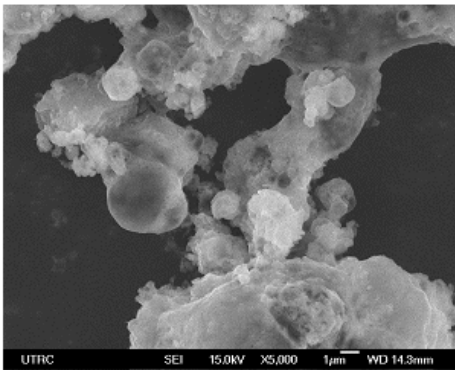
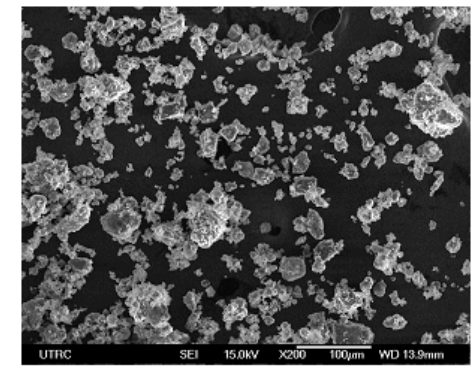

Used for projection

Prototype 2 material

Prototype 2 Fabrication

Finned Tube
Heat Exchanger

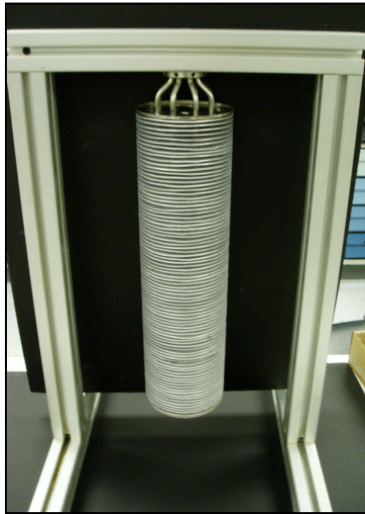

Stainless Steel Liner



Carbon Fiber / Epoxy
Overwrap



5' x 5' x 4' Assembly
Glove Box



Shaker System

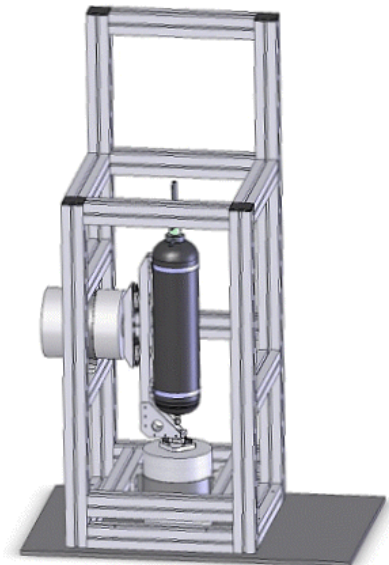

Prototype 2 Absorption Testing

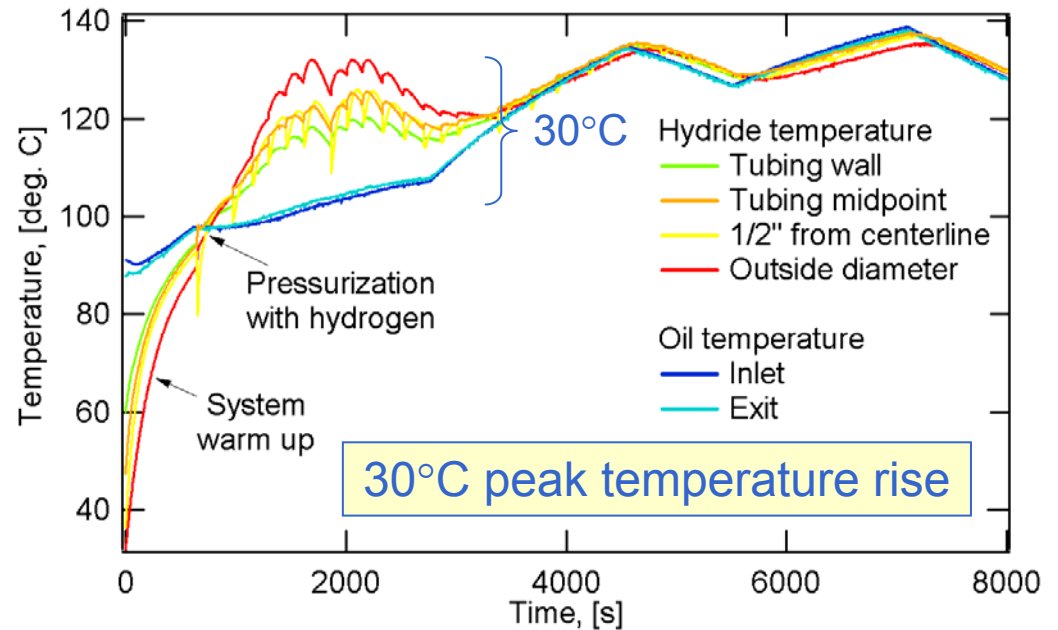
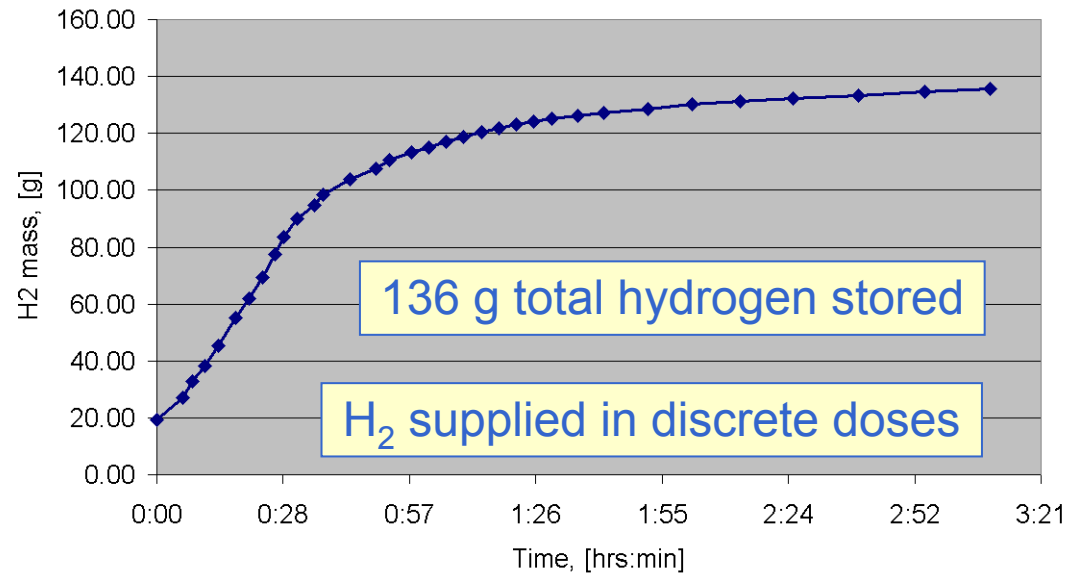
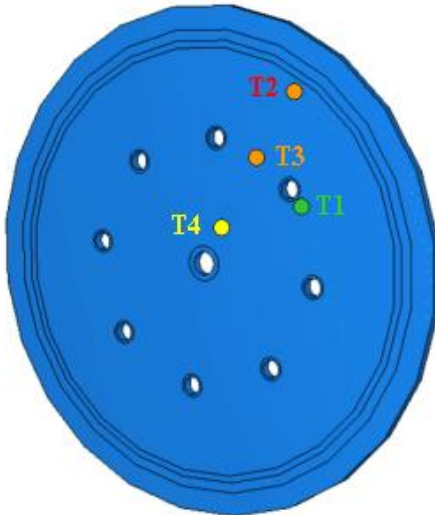
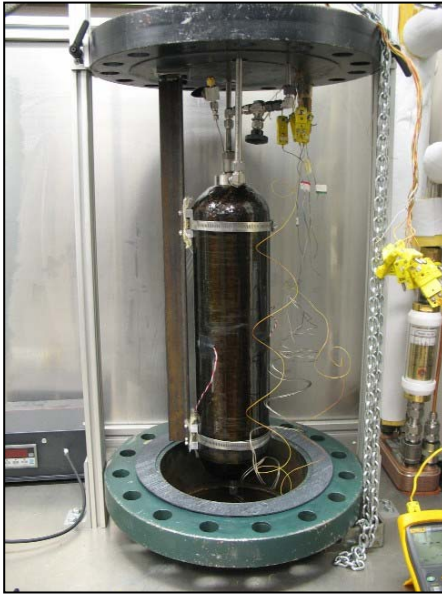

Prototype 2 Performance

- Hydride material: 3.5 kg total, 0.72 g/cc powder
- Gravimetric capacity = 0.020 (g H₂ / g System)
- Volumetric capacity = 0.021 (g H₂ / cc)

Weight

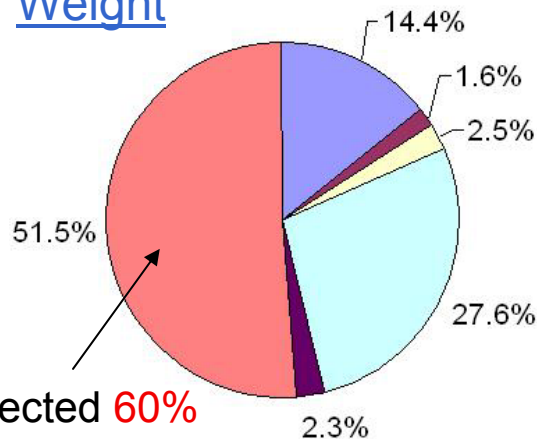

Volume

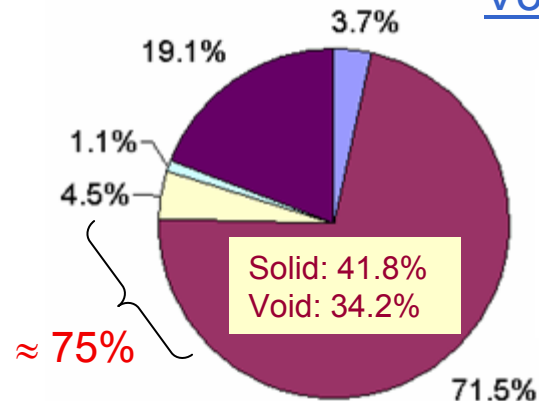
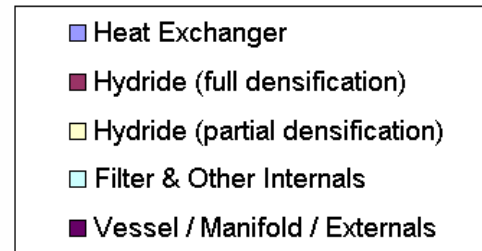

Intermediate prototype development goals met:

- Volumetrics: nominal efficiency of 75%
- Gravimetrics: with projection to full scale, efficiency of 60%

Reaction Kinetics Model – Prototype 2 Material

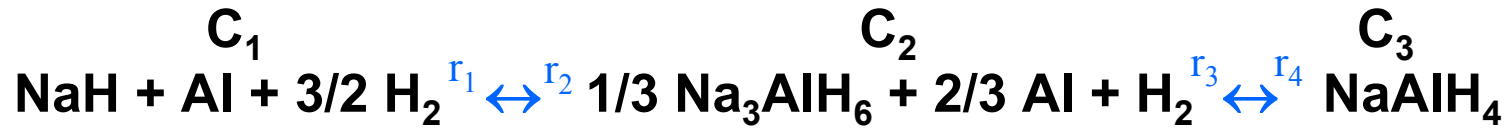

$$\left(\frac{dC_2}{dt}\right)_{r2} = A_2 \exp\left(-\frac{E_2}{RT}\right) * \left(\frac{P_{e,2} - P}{P_{e,2}}\right) * (C_1 - C_1^{sat} \text{ (X)})^{\chi_2}$$

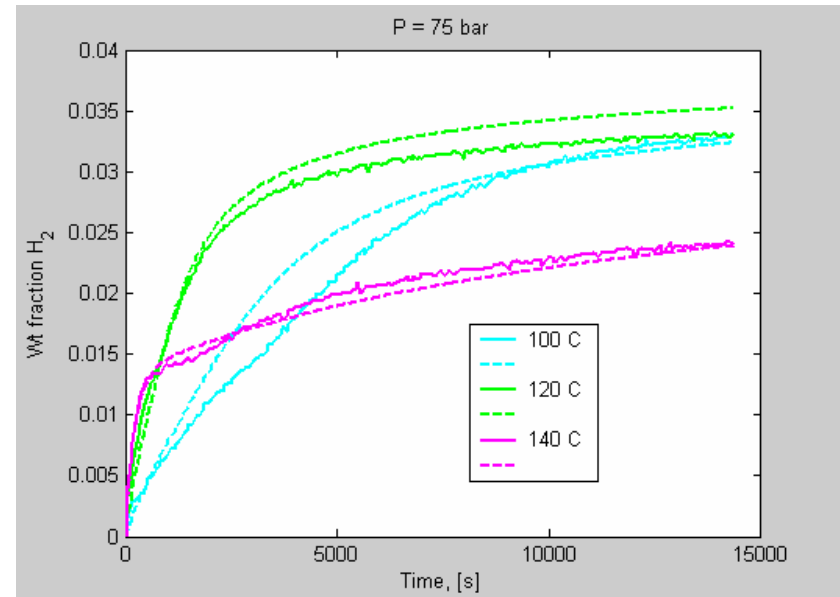
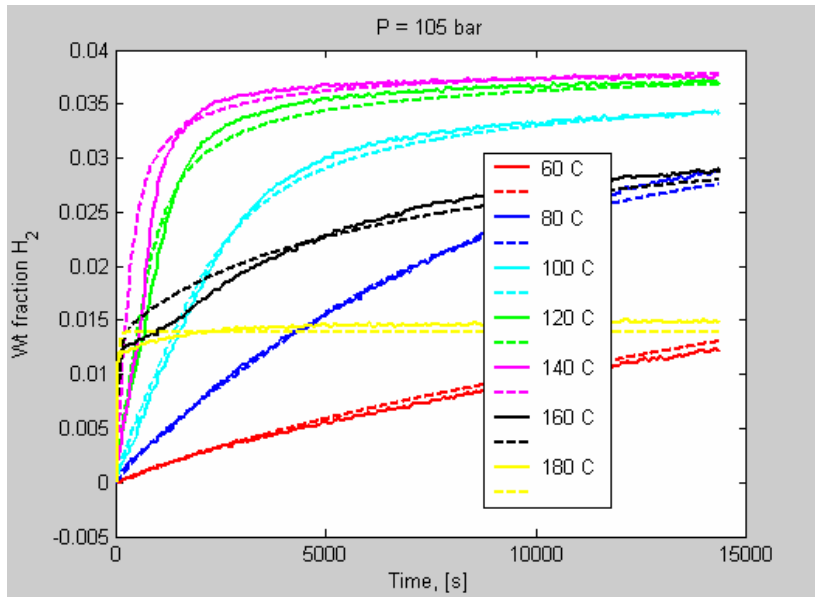

Two-reaction model was fit to kinetics data over ranges of T & P. Temperature dependence was eliminated for a model parameter representing non-ideal capacity.

Modeling: Finite Element Simulation

- Cross-section of system composed of 3D solid elements.
- Kinetics model implemented into ABAQUS and verified.
- Time variation of oil temperatures and hydrogen pressure specified.
- Fin / hydride layered detail represented by homogenized material.
- Transient thermochemical simulations conducted for absorption test.

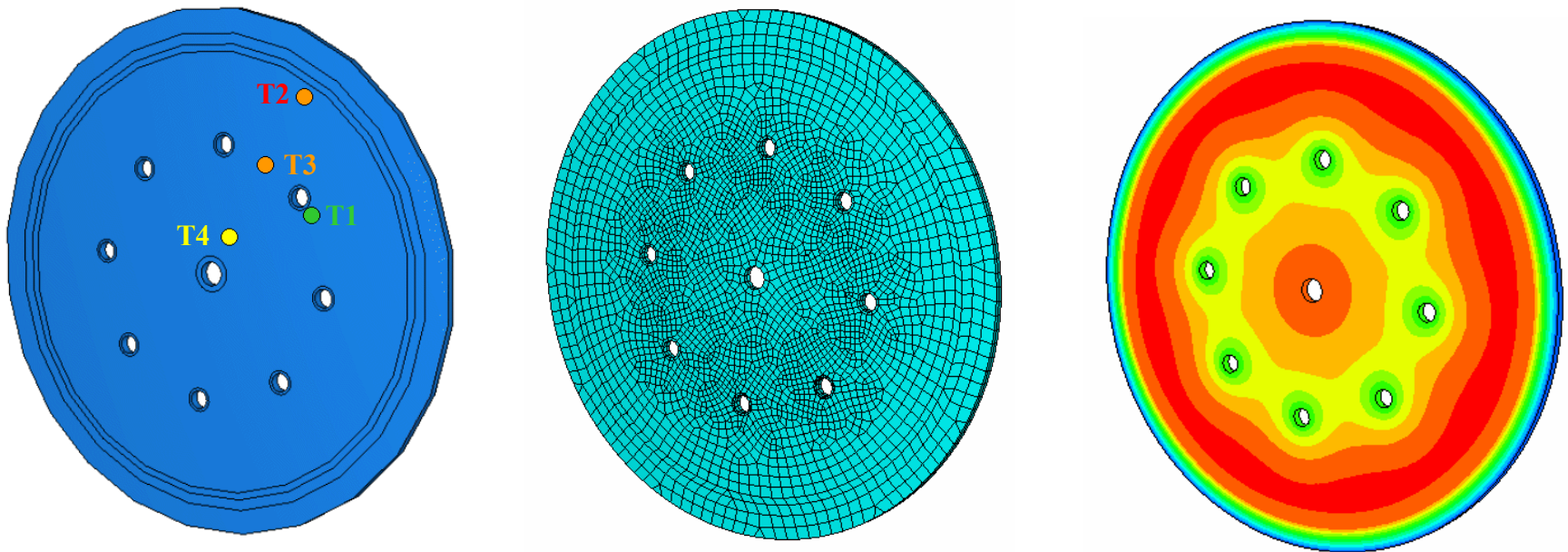

Modeling: Thermal Property Refinement

Data during absorption test warm-up period used to confirm most thermal properties and fine tune effective conductivity.

Baseline conditions

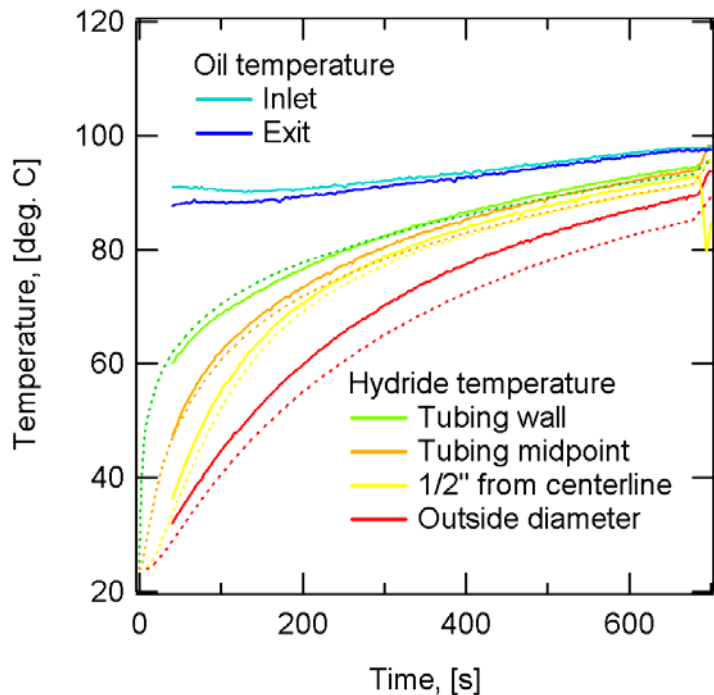

$k_{\text{eff}}: 4.3 \Rightarrow 6.0 \text{ W / m C}$

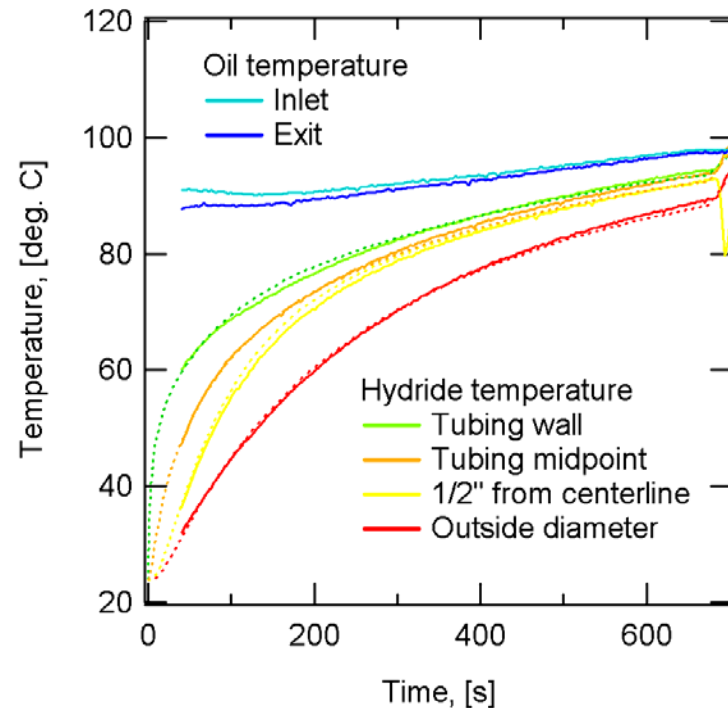

Dashed lines are simulation results

Very good agreement with minor adjustment to effective thermal conductivity.

Baseline Comparison

Dashed lines are simulation results

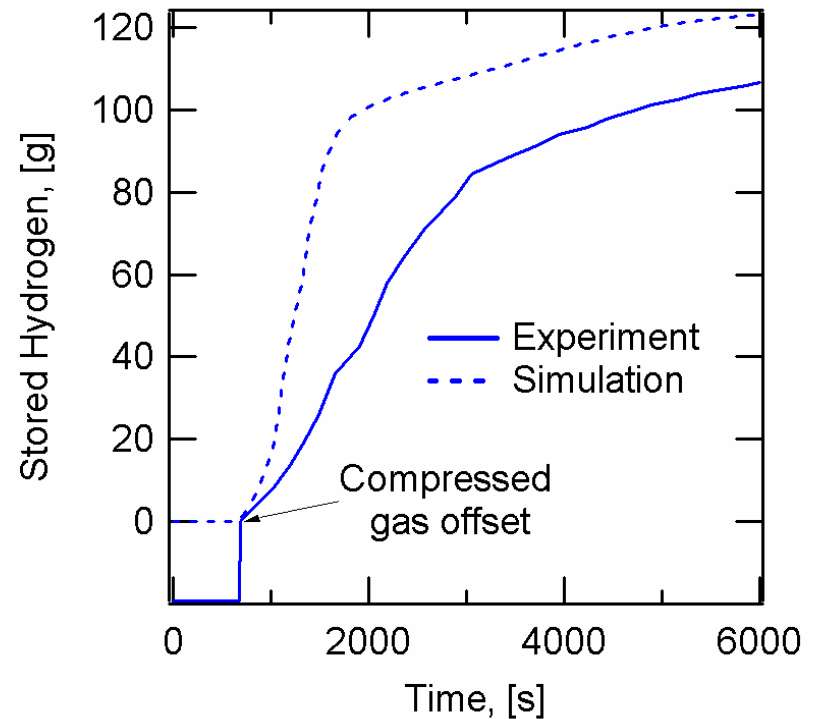
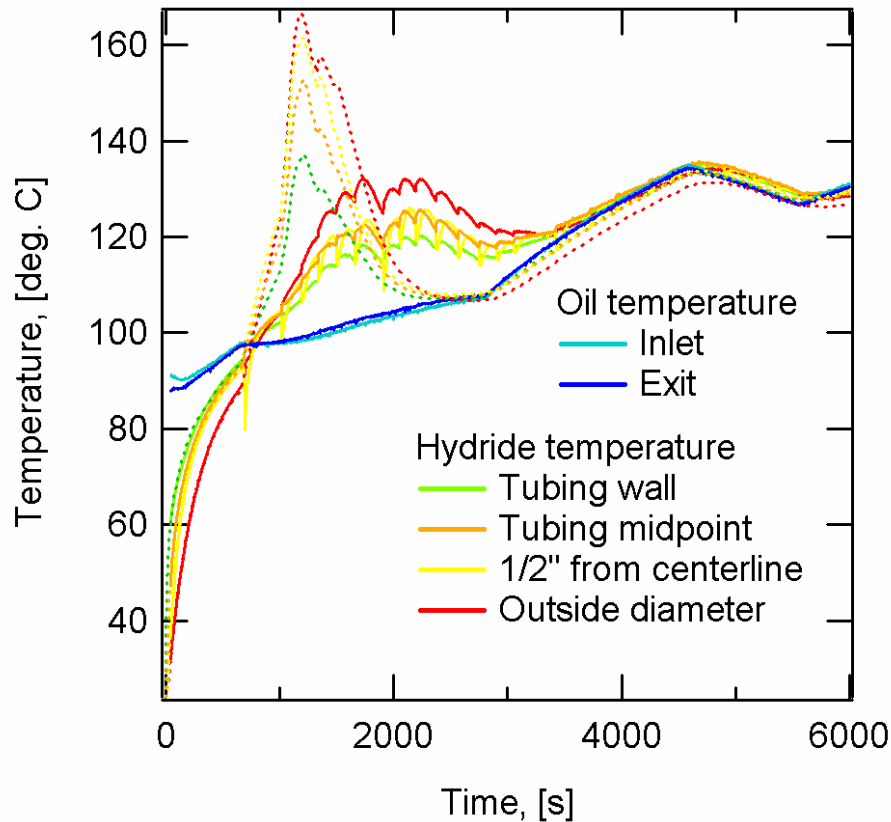

Predicted reactions occur more rapidly than prototype experiment.

Modified Kinetics

Introducing reaction rate reduction factor of nominally 0.5 while maintaining capacity gives good agreement.

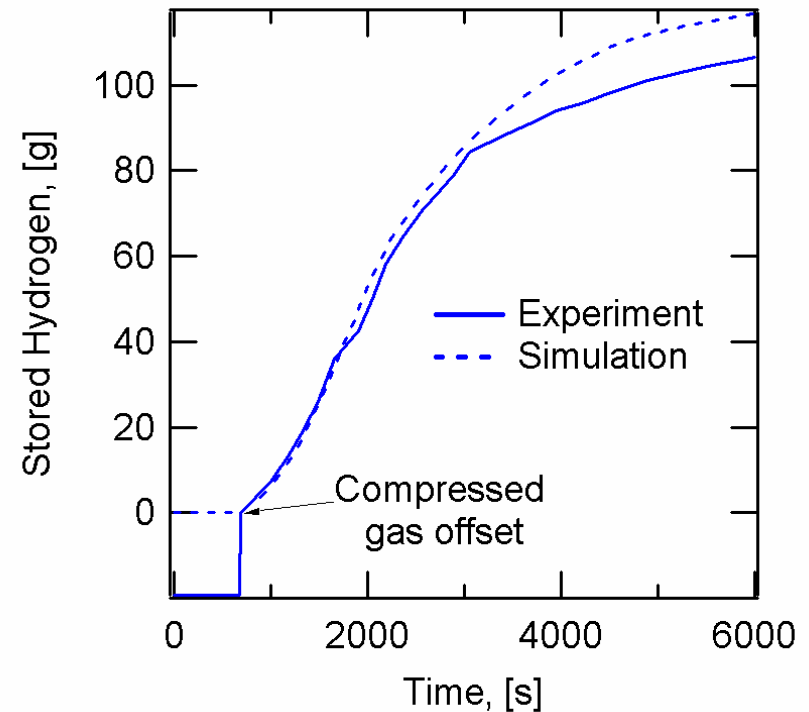
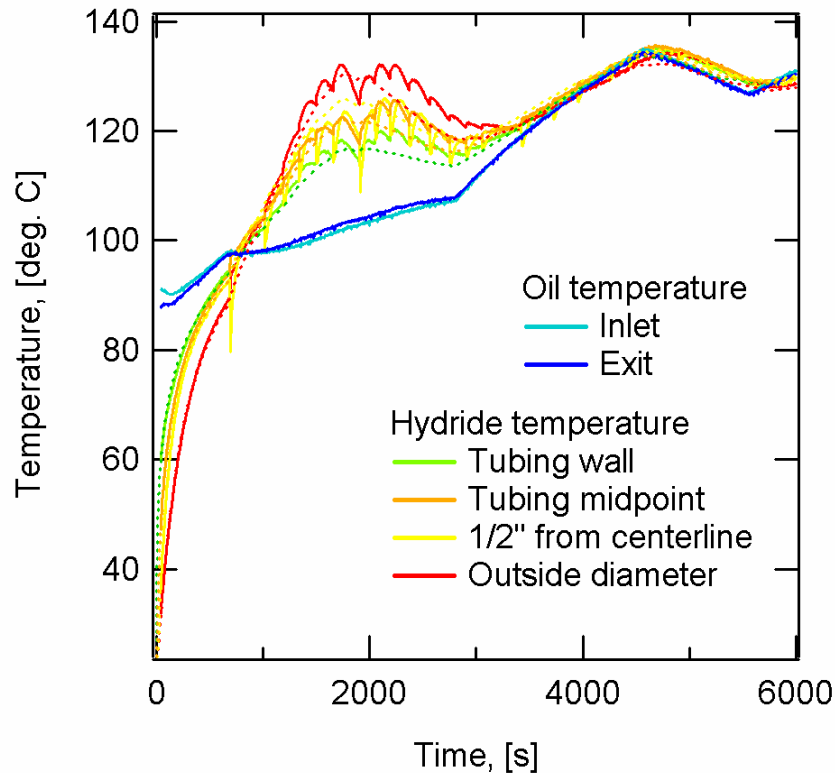

Simultaneous agreement of temperature and hydrogen mass indicates consistency of enthalpy, heat capacity and heat transfer.

Modeling Conclusions

- The absorption reaction curves for experiments conducted in a Sievert's apparatus on non-densified powder were represented reasonably well by the **kinetics model** over pressures from **75 to 105 bar** and temperatures from **60 to 180°C**.
- **Thermal only** transients were **predicted closely** for Prototype 2 with a minor adjustment of the effective thermal conductivity for the homogenized fin / hydride region.
- Simulation of Prototype 2 absorption **over-predicted the reaction rates**. Possible causes are
 - **Limited** hydrogen **mass transfer** due to the high level of **powder packing**
 - Moderate disagreement of the Sievert's data and kinetics model for a portion of the (T, P, t) conditions.
 - Possible system contamination that only affected the kinetics while having little effect on the capacity.
- The influence of cold hydrogen entering the system in doses was observed to produce secondary decreases in the temperature near the entrance filter. This phenomenon was not included in the present model.

Lessons Learned 1

- Perform system trade-off and design optimization modeling at a number of complexity levels:
 - Detailed models (spatial resolution, transient effects, ...) when needed and to support simplifying assumptions.
 - High level models to facilitate inclusion of a wider scope of phenomenological dependencies and for consistency checks.
- With prototypes containing highly reactive, air sensitive materials:
 - System design for manufacturing
 - Fabrication supporting hardware
 - Performance testing equipment with proper safetycan require a substantial fraction of development effort & resources.
- A $(1/2)^3 = 1/8$ scale system (1/8 kg H₂) provides a balance for reasonable hardware investment and the ability for performance projections to full scale, particularly for a first prototype with new materials and technologies.

Lessons Learned 2

Conduction Enhancement Types: Foam vs. Fins

Foam

- Advantages:
 - Fine length scales – good short range heat conduction (i.e. into hydride cell or layer)
 - Good strength for low relative densities
 - Easily incorporated into design
- Disadvantages:
 - 1/3 factor on conductivity affecting long range heat transport (i.e. between tubing)
 - Lack of flexibility for powder loading and migration mitigation
 - Cost

Fins

- Advantages:
 - Good long range heat conduction
 - Geometric flexibility
 - Cost
 - Disadvantages:
 - Must engineer for fine length scales having adequate short range conduction
 - Structurally weaker for a given average relative density
- Primary factors motivating use of fins in prototype 2 with improved performance

Lessons Learned 3 & Future Work

Lessons Learned

- Powder densification:
 - Can be challenging for many high capacity storage materials with low solid densities and nano-scale powder having low relative densities.
 - Is as significant as hydrogen weight percent for volumetric performance.
 - Can be achieved to high levels in preformed composite vessels containing heat exchangers using advanced techniques.
- Prototype projections based on platform material NaAlH_4 indicate realistic gravimetric efficiency of 60% and volumetric efficiency of 75%.
- Safety remains a critical concern for the application of highly reactive materials in on-board rechargeable storage systems.

Future Work

- Complete neutralization procedure on full-scale Prototype 1.
- Conclude contract final reporting and publishing.

Summary

2006 to 2007

- **Second prototype** was fabricated and tested to meet 9/30/06 **DOE Joule milestone**, achieving significant improvements over the first system.
- **Finned tube heat exchanger** was designed and fabricated with nominally a 30% weight reduction compared with the foam heat exchanger of Prototype 1.
- Successful system design-for-fabrication and powder packing enhancement methods increased **average density** from **0.44 to 0.72 g/cc** and were compatible with a conventional, domed composite vessel having small end ports.
- Even under high charging pressures of 100 bar and only moderately fast reaction kinetics for complex hydrides, with aggressive powder packing, inclusion of **mass transfer** for hydrogen gas appears to be required for accurate modeling.

Metric	Units	As-Fabricated		Projected	
		Prototype 1	Prototype 2	Prototype 1	Prototype 2
Gravimetric efficiency	<i>kg hyd. / kg sys.</i>	0.14	0.515	0.48	0.60 – 0.63
Gravimetric density	<i>% kg H2 / kg sys.</i>	0.4%	2.0%	1.7%	2.3%
Powder density	<i>g / cc</i>	0.44	0.72	0.60	0.85
Volumetric density	<i>Wh / L</i>	200	700	600	800